



# MERCEDES VAN SOLUTIONS

FOR SPRINTER AND METRIS VANS



Mercedes-Benz

# **weather guard** DESIGNED WITH THE PROFESSIONAL IN MIND

WEATHER GUARD® Van Solutions deliver unmatched organization, productivity, and durability, backed by a Limited Lifetime Warranty.



WEATHER GUARD® Van Solutions are ready to roll with game changing improvements based on years of research and your input. Completely retooled shelving, improved bulkheads, customizable organizational features, and a host of smart new accessories, designed around the common sense idea that tools and equipment belong on the shelf, not the floor.



# TABLE OF CONTENTS

The PRO PACKAGES for Mercedes Sprinter and Mercedes Metris vans on the next few pages can be used as a complete upfit package or a starting point for a custom upfit. Van layout dimensions are on the back cover if you're looking for something more custom or just need some detailed information about your van's interior. If you need more help, your local WEATHER GUARD® Truck and Van Equipment distributor is a great resource for all your upfitting questions.

<b>PRO PACKAGES</b> .....	<b>4-9</b>
Sprinter 144" WB .....	4-5
Sprinter 170" WB .....	6-7
Metris .....	8-9
<b>BULKHEADS</b> .....	<b>10</b>
<b>ADJUSTABLE SHELVING</b> .....	<b>11</b>
<b>SECURE STORAGE/ MOUNTING KITS</b> .....	<b>12</b>
<b>MOUNTING KITS</b> .....	<b>12</b>
<b>ACCESSORIES</b> .....	<b>13-14</b>
<b>CABINETS</b> .....	<b>16</b>
<b>DRAWER UNITS</b> .....	<b>17</b>
<b>ROOF RACKS</b> .....	<b>18</b>

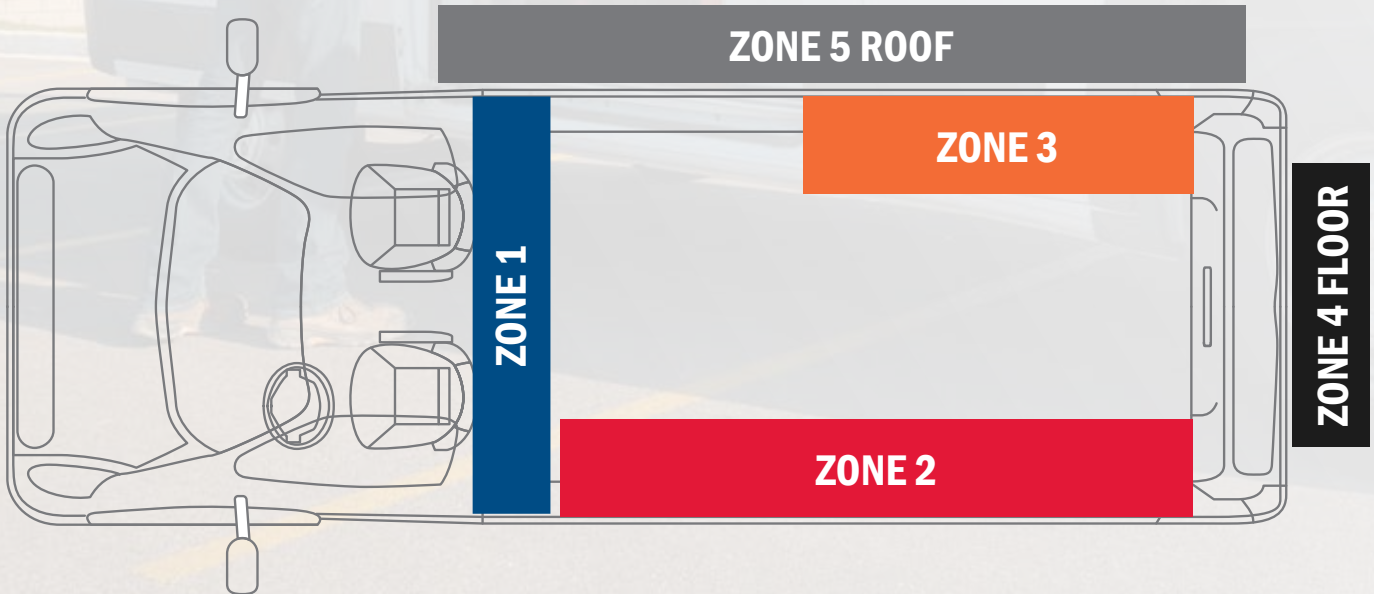



# SPRINTER PACKAGES 144" WHEEL BASE



**NEW!**

## Sprinter Mounting Kit

- Heavy gauge steel mounting plates distribute shelf load and provide secure mounting to van interior
- Mounts directly to reinforced weld nuts and cargo tie-downs or into existing holes (no drilling)
- Faster installation with reduced risk of damage to van during installation

MODEL	DESCRIPTION	WEIGHT
975301-3-01	Sprinter 144" WB SR, HR Mounting Kit	19 lbs.

## COMMERCIAL / BASE

DRIVER SIDE

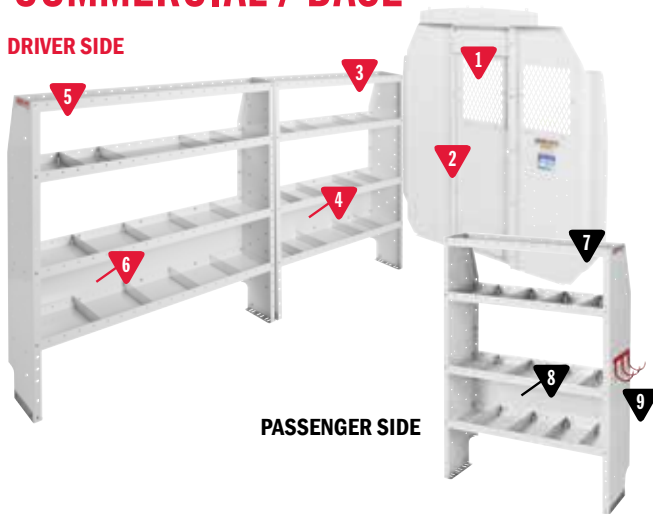

PASSENGER SIDE

## 600-8450R Commercial Shelving Package

MODEL	DESCRIPTION	QUANTITY
1	96122-3-01 Screen Bulkhead - Sprinter	1
2	96901-3-01 Swing Door Conversion Kit	1
3	9375-3-03 Adjustable 4 Shelf Unit (52" x 60" x 13½")	1
4	9605-3-01 Accessory Back Panel (for 52" shelf unit 14½" tall)	1
5	9376-3-03 Adjustable 4 Shelf Unit (60" x 60" x 13½")	1
6	9606-3-01 Accessory Back Panel (or 60" shelf unit 14½" tall)	1
7	9374-3-03 Adjustable 4 Shelf Unit (42" x 60" x 13½")	1
8	9604-3-01 Accessory Back Panel (for 42" shelf unit 14½" tall)	1
9	9893-7-01 REDZONE 3 Hook Cord or Tool Holder	1
*10	975301-3-01 Van Shelf Mounting Kit - Sprinter 144" WB	1

\* Not Shown

## GENERAL SERVICE / CONTRACTOR

DRIVER SIDE

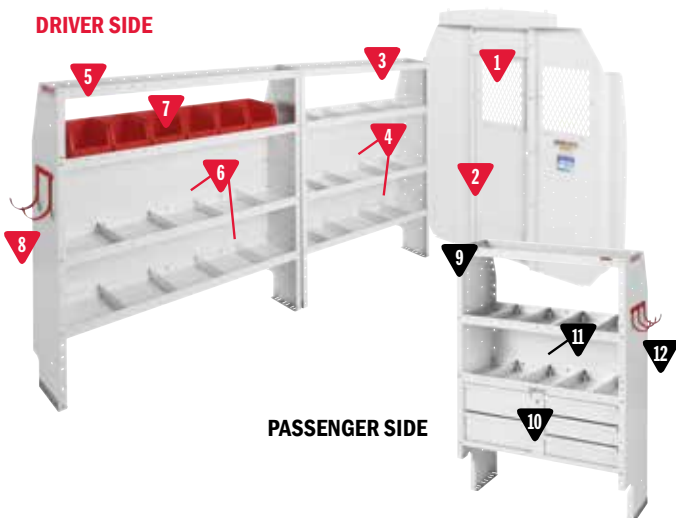

PASSENGER SIDE

## 600-8451R General Service/Contractor Package

MODEL	DESCRIPTION	QUANTITY
1	96122-3-01 Screen Bulkhead - Sprinter	1
2	96901-3-01 Swing Door Conversion Kit	1
3	9375-3-03 Adjustable 4 Shelf Unit (52" x 60" x 13½")	1
4	9605-3-01 Accessory Back Panel (for 52" shelf unit 14½" tall)	2
5	9376-3-03 Adjustable 4 Shelf Unit (60" x 60" x 13½")	1
6	9606-3-01 Accessory Back Panel (for 60" shelf unit 14½" tall)	2
7	9859-7-01 REDZONE Medium 6 Bin Set (13")	1
8	9892-7-01 REDZONE 2 Hook Holder (5" diameter)	1
9	9391-3-03 Heavy Duty Shelf Unit (for Secure Storage Modules - 42" x 60" x 16")	1
10	9045-3-02 5 Drawer Secure Storage Module (42" x 17" x 16")	1
11	9604-3-01 Accessory Back Panel (for 42" shelf unit 14½" tall)	1
12	9893-7-01 REDZONE 3 Hook Cord or Tool Holder	1
*13	975301-3-01 Van Shelf Mounting Kit - Sprinter 144" WB	1

\* Not Shown

## CABLE / PLUMBING

DRIVER SIDE

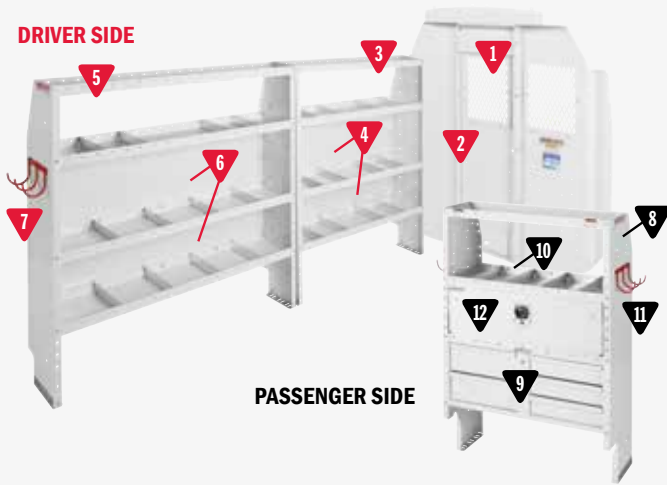

PASSENGER SIDE

### 600-8452R Cable/Plumber Package

MODEL	DESCRIPTION	QUANTITY
1	96122-3-01 Screen Bulkhead - Sprinter	1
2	96901-3-01 Swing Door Conversion Kit	1
3	9375-3-03 Adjustable 4 Shelf Unit (52" x 60" x 13½")	1
4	9605-3-01 Accessory Back Panel (for 52" shelf unit 14½" tall)	2
5	9376-3-03 Adjustable 4 Shelf Unit (60" x 60" x 13½")	1
6	9606-3-01 Accessory Back Panel (for 60" shelf unit 14½" tall)	2
7	9893-7-01 REDZONE 3 Hook Cord or Tool Holder	1
8	9391-3-03 Heavy Duty Shelf Unit (for Secure Storage Modules - 42" x 60" x 16")	1
9	9045-3-02 5 Drawer Secure Storage Module (42" x 17" x 16")	1
10	9604-3-01 Accessory Back Panel (for 42" shelf unit 14½" tall)	1
11	9893-7-01 REDZONE 3 Hook Cord or Tool Holder	1
12	9504-3-01 Shelf Door (for 42" shelf unit)	1
*13	975301-3-01 Van Shelf Mounting Kit = Sprinter 144" WB	1

\* Not Shown

## HVAC / MECHANICAL

DRIVER SIDE



PASSENGER SIDE

### 600-8453R HVAC/Mechanical Package

MODEL	DESCRIPTION	QUANTITY
1	96122-3-01 Screen Bulkhead - Sprinter	1
2	96901-3-01 Swing Door Conversion Kit	1
3	9375-3-03 Adjustable 4 Shelf Unit (52" x 60" x 13½")	1
4	9505-3-01 Shelf Door (for 52" shelf unit)	1
5	9605-3-01 Accessory Back Panel (for 52" shelf unit 14½" tall)	2
6	9376-3-03 Adjustable 4 Shelf Unit (60" x 60" x 13½")	1
7	9606-3-01 Accessory Back Panel (for 60" shelf unit 14½" tall)	2
8	9859-7-01 REDZONE Medium 6 Bin Set (13")	1
9	9880-3-01 Literature Holder 6 Compartment	1
10	9863-3-01 Refrigerant Tank Rack (2x 30#, 1x 50#)	1
11	9391-3-03 Heavy Duty Shelf Unit (for Secure Storage Modules - 42" x 60" x 16")	1
12	9045-3-02 5 Drawer Secure Storage Module (42" x 17" x 16")	1
13	9893-7-01 REDZONE 3 Hook Cord or Tool Holder	1
*14	975301-3-01 Van Shelf Mounting Kit - Sprinter 144" WB	1

\* Not Shown

## ELECTRICAL

DRIVER SIDE

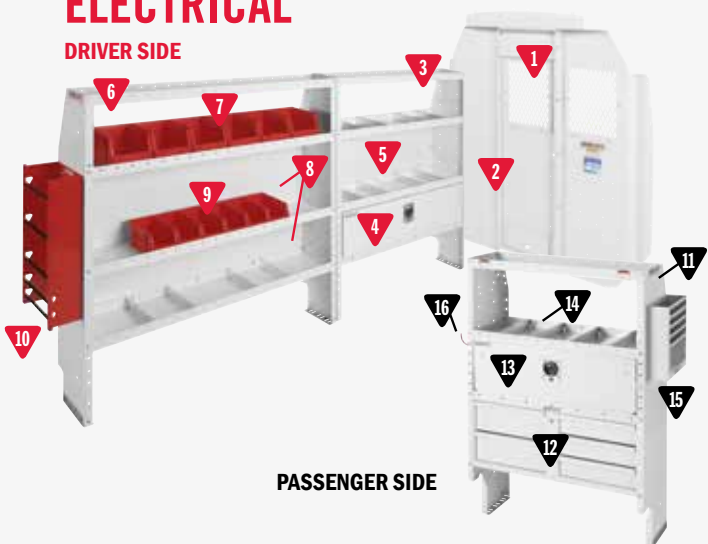

PASSENGER SIDE

### 600-8454R Electrical Package

MODEL	DESCRIPTION	QUANTITY
1	96122-3-01 Screen Bulkhead - Sprinter	1
2	96901-3-01 Swing Door Conversion Kit	1
3	9375-3-03 Adjustable 4 Shelf Unit (52" x 60" x 13½")	1
4	9505-3-01 Shelf Door (for 52" shelf unit)	1
5	9605-3-01 Accessory Back Panel (for 52" shelf unit 14½" tall)	2
6	9376-3-03 Adjustable 4 Shelf Unit (60" x 60" x 13 ½")	1
7	9859-7-01 REDZONE Medium 6 Bin Set (13")	1
8	9606-3-01 Accessory Back Panel (for 60" shelf unit 14½" tall)	2
9	9858-7-01 REDZONE Small 6 Bin Set (13")	1
10	9882-7-01 REDZONE Wire Spool Holder End Mount	1
11	9391-3-03 Heavy Duty Shelf Unit (for Secure Storage Modules - 42" x 60" x 16")	1
12	9045-3-02 5 Drawer Secure Storage Module (42" x 17" x 16")	1
13	9504-3-01 Shelf Door (for 42" shelf unit)	1
14	9604-3-02 Accessory Back Panel (for 42" shelf unit 14½" tall)	2
15	9880-3-01 Literature Holder 6 Compartment	1
16	9893-7-01 REDZONE 3 Hook Cord or Tool Holder	1
*17	975301-3-01 Van Shelf Mounting Kit - Sprinter 144" WB	1

\* Not Shown

# SPRINTER PACKAGES 170" WB / 170" WB - EXTENDED LENGTH



**NEW!**

Our Pro Packages help you organize your equipment and supplies, large and small. From recipis, drills and hand tools to expensive test equipment, the packages are customizable to meet your specific storage needs with a wide range of accessories starting on page 13.

## Sprinter Mounting Kit

- Heavy gauge steel mounting plates distribute shelf load and provide secure mounting to van interior
- Mounts directly to reinforced weld nuts and cargo tie-downs or into existing holes (no drilling)
- Faster installation with reduced risk of damage to van during installation

MODEL	DESCRIPTION	WEIGHT
975301-3-01	Sprinter 170" WB SR, HR Mounting Kit	25 lbs.

## COMMERCIAL / BASE

DRIVER SIDE

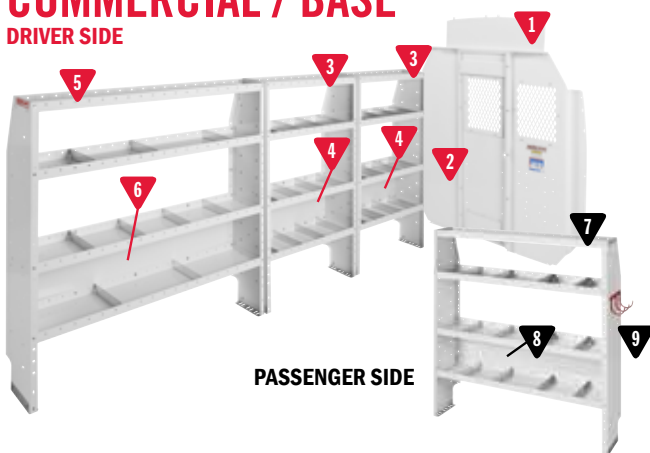

PASSENGER SIDE

## 600-8450L Commercial Shelving Package

MODEL	DESCRIPTION	QUANTITY
1	96122-3-01 Screen Bulkhead - Sprinter	1
2	96901-3-01 Swing Door Conversion Kit	1
3	9373-3-03 Adjustable 4 Shelf Unit (36" x 60" x 13½")	2
4	9603-3-01 Accessory Back Panel (for 36" shelf unit 14½" tall)	2
5	9376-3-03 Adjustable 4 Shelf Unit (60" x 60" x 13½")	1
6	9606-3-01 Accessory Back Panel (or 60" shelf unit 14½" tall)	1
7	9376-3-03 Adjustable 4 Shelf Unit (60" x 60" x 13½")	1
8	9606-3-01 Accessory Back Panel (for 60" shelf unit 14½" tall)	1
9	9893-7-01 REDZONE 3 Hook Cord or Tool Holder	1
*10	975302-3-01 Van Shelf Mounting Kit - Sprinter 170" WB	1

\* Not Shown

## GENERAL SERVICE / CONTRACTOR

DRIVER SIDE

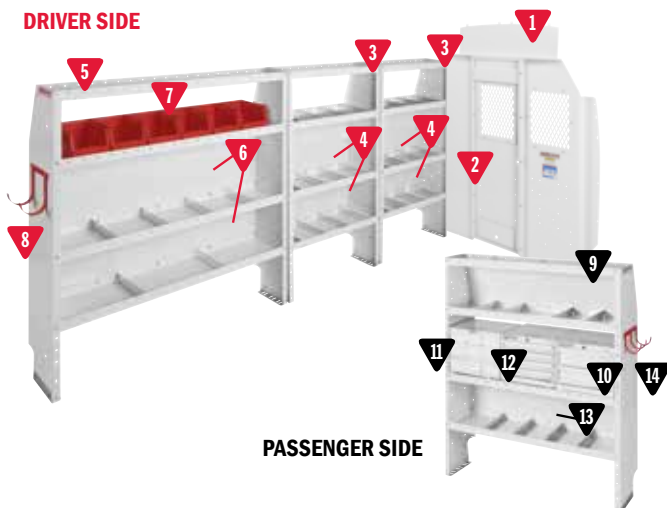

PASSENGER SIDE

## 600-8451L General Service/Contractor Package

MODEL	DESCRIPTION	QUANTITY
1	96122-3-01 Screen Bulkhead - Sprinter	1
2	96901-3-01 Swing Door Conversion Kit	1
3	9373-3-03 Adjustable 4 Shelf Unit (36" x 60" x 13½")	2
4	9603-3-01 Accessory Back Panel (for 36" shelf unit 14½" tall)	4
5	9376-3-03 Adjustable 4 Shelf Unit (60" x 60" x 13½")	1
6	9606-3-01 Accessory Back Panel (for 60" shelf unit 14½" tall)	2
7	9859-7-01 REDZONE Medium 6 Bin Set (13")	1
8	9892-7-01 REDZONE 2 Hook Holder (5" diameter)	1
9	9375-3-03 Adjustable 4 Shelf Unit (52" x 60" x 13½")	1
10	9912-3-02 2 Drawer Cabinet (16" x 14" x 12")	1
11	9909-3-02 Parts Cabinet 9 Bin (16" x 12" x 12")	1
12	9914-3-02 4 Drawer Cabinet (16" x 14" x 12")	1
13	9605-3-01 Accessory Back Panel (for 52" shelf unit 14½" tall)	1
14	9893-7-01 REDZONE 3 Hook Cord or Tool Holder	1
*15	975302-3-01 Van Shelf Mounting Kit - Sprinter 170" WB	1

\* Not Shown

# CABLE / PLUMBING

DRIVER SIDE

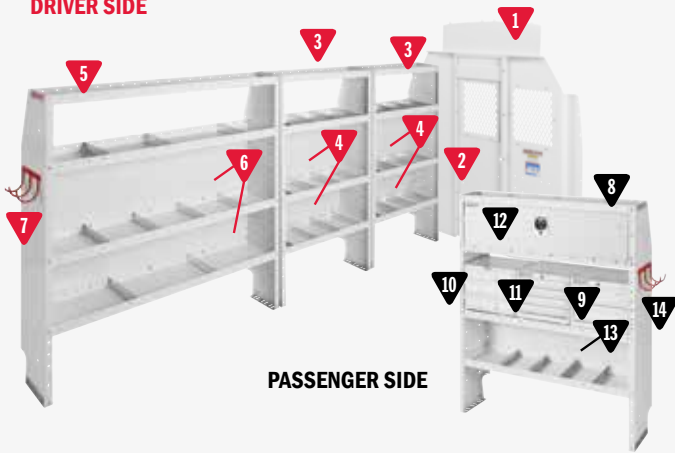

## 600-8452L Cable/Plumber Package

MODEL	DESCRIPTION	QUANTITY
1	96122-3-01 Screen Bulkhead - Sprinter	1
2	96901-3-01 Swing Door Conversion Kit	1
3	9373-3-03 Adjustable 4 Shelf Unit (36" x 60" x 13½")	2
4	9603-3-01 Accessory Back Panel (for 36" shelf unit 14½" tall)	4
5	9376-3-03 Adjustable 4 Shelf Unit (60" x 60" x 13½")	1
6	9506-3-01 Accessory Back Panel (for 60" shelf unit 14½" tall)	2
7	9893-7-01 REDZONE 3 Hook Cord or Tool Holder	1
8	9375-3-03 Adjustable 4 Shelf Unit (52" x 60" x 13½")	1
9	9912-3-02 2 Drawer Cabinet (16" x 14" x 12")	1
10	9909-3-02 Parts Cabinet 9 Bin (16" x 12" x 12")	1
11	9914-3-02 4 Drawer Cabinet (16" x 14" x 12")	1
12	9505-3-01 Shelf Door (for 52" shelf unit)	1
13	9605-3-01 Accessory Back Panel (for 52" shelf unit 14½" tall)	1
14	9893-7-01 REDZONE 3 hook cord or tool holder	1

\*15 975302-3-01 Van Shelf Mounting Kit - Sprinter 170" WB

\* Not Shown

# HVAC / MECHANICAL

DRIVER SIDE

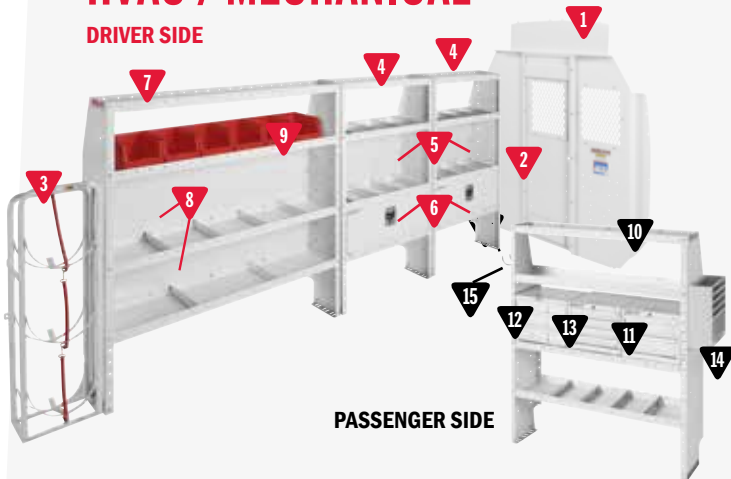

## 600-8453L HVAC/Mechanical Package

MODEL	DESCRIPTION	QUANTITY
1	96122-3-01 Screen Bulkhead - Sprinter	1
2	96901-3-01 Swing Door Conversion Kit	1
3	9863-3-01 Refrigerant Tank Rack (2x 30#, 1x 50#)	1
4	9373-3-03 Adjustable 4 Shelf Unit (36" x 60" x 13½")	2
5	9603-3-01 Accessory Back Panel (for 36" shelf unit 14½" tall)	4
6	9503-3-01 Shelf Door (for 36" shelf unit)	2
7	9376-3-03 Adjustable 4 Shelf Unit (60" x 60" x 13½")	4
8	9606-3-02 Accessory Back Panel (for 60" shelf unit 14½" tall)	2
9	9859-7-01 REDZONE Medium 6 Bin Set (13")	1
10	9375-3-03 Adjustable 4 Shelf Unit (52" x 60" x 13½")	1
11	9912-3-02 2 Drawer Cabinet (16" x 14" x 12")	1
12	9909-3-02 Parts Cabinet 9 Bin (16" x 12" x 12")	1
13	9914-3-02 4 Drawer Cabinet (16" x 14" x 12")	1
14	9880-3-01 Literature Holder 6 Compartment	1
15	9893-7-01 REDZONE 3 Hook Cord or Tool Holder	1

\*16 975302-3-01 Van Shelf Mounting Kit - Sprinter 170" WB

\* Not Shown

# ELECTRICAL

DRIVER SIDE

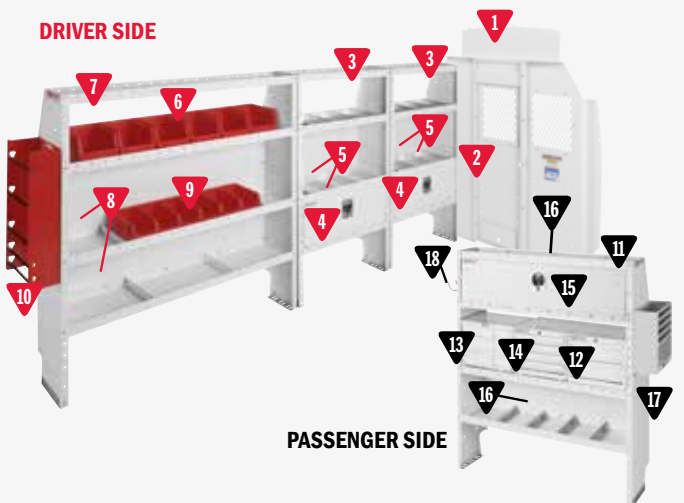

## 600-8454L Electrical Package

MODEL	DESCRIPTION	QUANTITY
1	96122-3-01 Screen Bulkhead - Sprinter	1
2	96901-3-01 Swing Door Conversion Kit	1
3	9373-3-03 Adjustable 4 Shelf Unit (36" x 60" x 13½")	2
4	9503-3-01 Shelf Door (for 36" shelf unit)	2
5	9603-3-01 Accessory Back Panel (for 36" shelf unit 14½" tall)	4
6	9859-7-01 REDZONE Medium 6 Bin Set (13")	1
7	9376-3-03 Adjustable 4 Shelf Unit (60" x 60" x 13 ½")	1
8	9606-3-01 Accessory Back Panel (for 60" shelf unit 14½" tall)	2
9	9858-7-01 REDZONE Small 6 Bin Set (13")	1
10	9882-7-01 REDZONE Wire Spool Holder End Mount	1
11	9375-3-03 Adjustable 4 Shelf Unit (52" x 60" x 13 ½")	1
12	9912-3-02 2 Drawer Cabinet (16" x 14" x 12")	1
13	9909-3-02 Parts Cabinet 9 Bin (16" x 12" x 12")	1
14	9914-3-02 4 Drawer Cabinet (16" x 14" x 12")	1
15	9505-3-01 Shelf Door (for 52" shelf unit)	1
16	9605-3-01 Accessory Back Panel (for 52" shelf unit 14½" tall)	2
17	9880-3-01 Literature Holder 6 Compartment	1
18	9893-7-01 REDZONE 3 Hook Cord or Tool Holder	1

\*19 975302-3-01 Van Shelf Mounting Kit - Sprinter 170" WB

\* Not Shown



# METRIS PACKAGES

Keep it simple with room for the busiest days or fully load it up with shelves, drawers and bins to keep everything organized. Your Metris works just as hard any other van on the road. Customize for your needs with accessories starting on page 13.

**NEW!**



## Metris Mounting Kit

- Heavy gauge steel mounting plates distribute shelf load and provide secure mounting to van interior
- Mounts directly to reinforced weld nuts and cargo tie-downs or into existing holes (no drilling)
- Faster installation with reduced risk of damage to van during installation

MODEL	DESCRIPTION	WEIGHT
9753-3-01	Rear Shelf Mounting Kit	13 lbs.

## COMMERCIAL / BASE

DRIVER SIDE

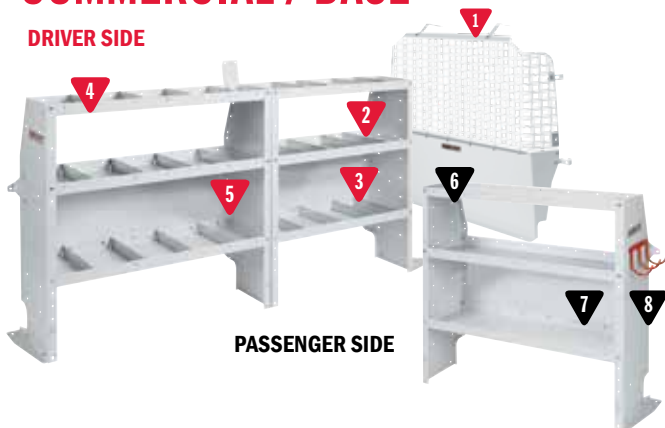

PASSENGER SIDE

## 600-8350 Commercial Shelving Package

MODEL	DESCRIPTION	QUANTITY
1	96113-3-01 Mesh Bulkhead - Metris	1
2	9353-3-03 Adjustable 3 Shelf Unit (36" x 44" x 13½")	1
3	9603-3-01 Accessory Back Panel (for 36" shelf unit 14½" tall)	1
4	9354-3-03 Adjustable 3 Shelf Unit (42" x 44" x 13½")	1
5	9604-3-01 Accessory Back Panel (or 42" shelf unit 14½" tall)	1
6	9354-3-03 Adjustable 3 Shelf Unit (42" x 44" x 13½")	1
7	9604-3-01 Accessory Back Panel (for 42" shelf unit 14½" tall)	1
8	9893-7-01 REDZONE 3 Hook Cord or Tool Holder	1
*9	9753-3-01 Van Shelf Mounting Kit (for Metris)	1

\* Not Shown

## GENERAL SERVICE / CONTRACTOR

DRIVER SIDE

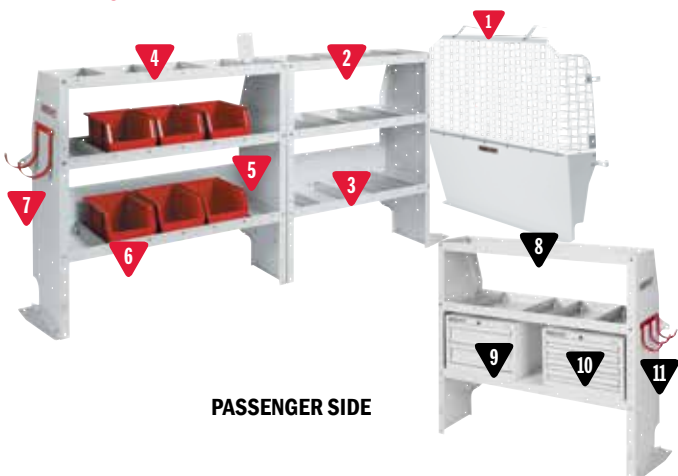

PASSENGER SIDE

## 600-8351 General Service/Contractor Package

MODEL	DESCRIPTION	QUANTITY
1	96113-3-01 Mesh Bulkhead - Metris	1
2	9353-3-03 Adjustable 3 Shelf Unit (36" x 44" x 13½")	2
3	9603-3-01 Accessory Back Panel (for 36" shelf unit 14½" tall)	4
4	9354-3-03 Adjustable 3 Shelf Unit (42" x 44" x 13½")	1
5	9604-3-01 Accessory Back Panel (for 42" shelf unit 14½" tall)	2
6	9859-7-01 REDZONE Medium 6 Bin Set (13")	1
7	9892-7-01 REDZONE 2 Hook Holder (5" diameter)	1
8	9354-3-03 Adjustable 3 Shelf Unit (42" x 44" x 13½")	1
9	9912-3-02 2 Drawer Cabinet (16" x 14" x 12")	1
10	9914-3-02 4 Drawer Cabinet (16" x 14" x 12")	1
11	9893-7-01 REDZONE 3 Hook Cord or Tool Holder	1
*12	9753-3-01 Van Shelf Mounting Kit (for Metris)	1

\* Not Shown



## CABLE / PLUMBING

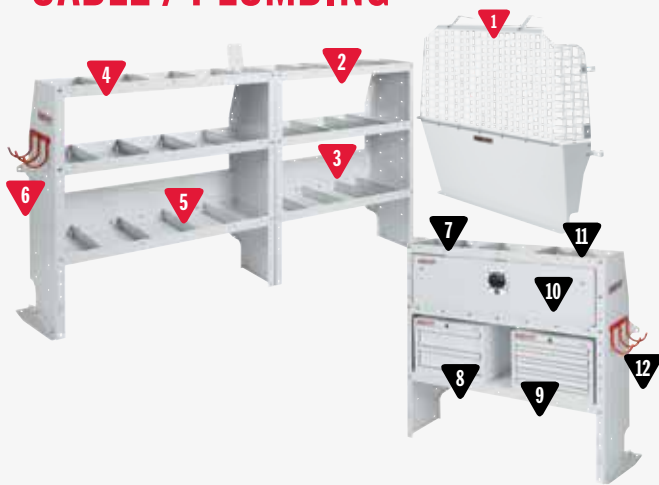

### 600-8352 Cable/Plumber Package

MODEL	DESCRIPTION	QUANTITY
1	96113-3-01 Mesh Bulkhead - Metris	1
2	9353-3-03 Adjustable 3 Shelf Unit (36" x 44" x 13½")	1
3	9603-3-01 Accessory Back Panel (for 36" shelf unit 14½" tall)	1
4	9354-3-03 Adjustable 3 Shelf Unit (42" x 44" x 13½")	1
5	9604-3-01 Accessory Back Panel (for 42" shelf unit 14½" tall)	2
6	9893-7-01 REDZONE 3 Hook Cord or Tool Holder	1
7	9354-3-03 Adjustable 3 Shelf Unit (42" x 44" x 13½")	1
8	9912-3-02 2 Drawer Cabinet (16" x 14" x 12")	1
9	9914-3-02 4 Drawer Cabinet (16" x 14" x 12")	1
10	9504-3-01 Shelf Door (for 42" shelf unit)	1
11	9604-3-01 Accessory Back Panel (for 42" shelf unit 14½" tall)	1
12	9893-7-01 REDZONE 3 hook cord or tool holder	1
*13	9753-3-01 Van Shelf Mounting Kit (for Metris)	1

\* Not Shown

## HVAC / MECHANICAL

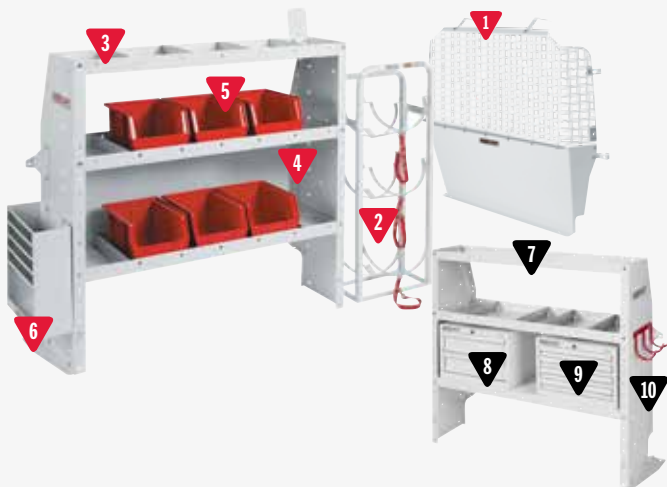

### 600-8353 HVAC/Mechanical Package

MODEL	DESCRIPTION	QUANTITY
1	96113-3-01 Mesh Bulkhead - Metris	1
2	9863-3-01 Refrigerant Tank Rack (2x 30#, 1x 50#)	1
3	9354-3-03 Adjustable 3 Shelf Unit (42" x 44" x 13½")	1
4	9604-3-01 Accessory Back Panel (for 42" shelf unit 14½" tall)	1
5	9859-7-01 REDZONE Medium 6 Bin Set (13")	1
6	9880-3-01 Literature Holder 6 Compartment	1
7	9354-3-03 Adjustable 3 Shelf Unit (42" x 44" x 13½")	1
8	9912-3-02 2 Drawer Cabinet (16" x 14" x 12")	1
9	9914-3-02 4 Drawer Cabinet (16" x 14" x 12")	1
10	9893-7-01 REDZONE 3 Hook Cord or Tool Holder	1
*11	9753-3-01 Van Shelf Mounting Kit (for Metris)	1

\* Not Shown

## ELECTRICAL

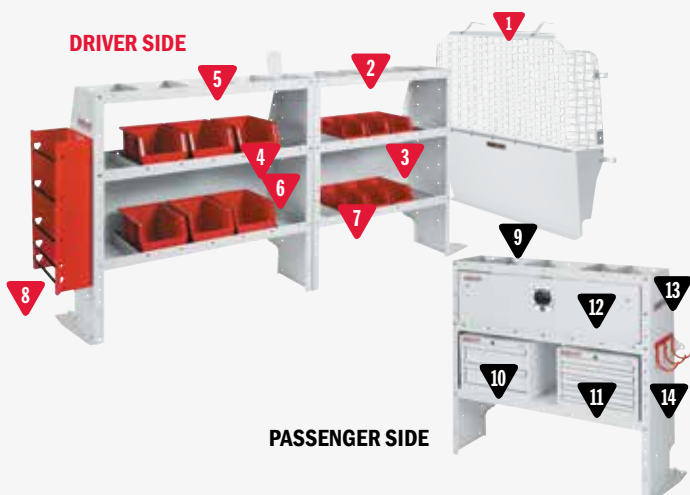

### 600-8354 Electrical Package

MODEL	DESCRIPTION	QUANTITY
1	96113-3-01 Mesh Bulkhead - Metris	1
2	9353-3-03 Adjustable 3 Shelf Unit (36" x 44" x 13½")	1
3	9603-3-01 Accessory Back Panel (for 36" shelf unit 14½" tall)	1
4	9859-7-01 REDZONE Medium 6 Bin Set (13")	1
5	9354-3-03 Adjustable 4 Shelf Unit (42" x 44" x 13 ½")	1
6	9604-3-01 Accessory Back Panel (for 42" shelf unit 14½" tall)	2
7	9858-7-01 REDZONE Small 6 Bin Set (13")	1
8	9882-7-01 REDZONE Wire Spool Holder End Mount	1
9	9354-3-03 Adjustable 3 Shelf Unit (42" x 44" x 13 ½")	1
10	9912-3-02 2 Drawer Cabinet (16" x 14" x 12")	1
11	9914-3-02 4 Drawer Cabinet (16" x 14" x 12")	1
12	9504-3-01 Shelf Door (for 42" shelf unit)	1
13	9604-3-01 Accessory Back Panel (for 42" shelf unit 14½" tall)	2
14	9893-7-01 REDZONE 3 Hook Cord or Tool Holder	1
*15	9753-3-01 Van Shelf Mounting Kit (for Metris)	1

\* Not Shown

# BULKHEADS

WEATHER GUARD® Van Bulkheads separate the driver compartment from the cargo area for maximum protection against shifting loads. Polycarbonate windows reduce noise and provide visibility through the bulkhead. The angled design cuts glare to improve visibility and safety. Bulkhead accessories are available to make the most of organization space in your van. Deep offset bulkheads provide superior comfort in the cab area allowing full seat travel.



Model 96121-3-01

Model 96122-3-01

## Bulkheads for Sprinter

Offers improved visibility and a large area for accessory mounts and holders while providing safety and security for occupants and cargo. Includes header panels for standard and high roof bars.

MODEL	DESCRIPTION	WEIGHT
96121-3-01	Window Bulkhead	105 lbs.
96122-3-01	Screen Bulkhead	105 lbs.
96901-3-01	Hinge Kit converts bulkhead to swinging door with lockable latch	4 lbs.
96903-3-01	Solid Bulkhead Panel Adapter Kit	10 lbs.



Model 96113-3-01

Model 96513-3-01

## Bulkheads for Metris

MODEL	DESCRIPTION	WEIGHT
96113-3-01	Mesh Bulkhead	69 lbs.
96513-3-01	Window Bulkhead	69 lbs.

## BULKHEAD RED ZONE ACCESSORIES

WEATHER GUARD® Bulkhead Accessories let you create a custom storage solution that securely organizes the items you need to locate quickly and easily.



## Bulkhead Accessories

MODEL	DESCRIPTION	WEIGHT
1 9879-7-01	Tool Organizer	3 lbs.
2 8875	Hard Hat Bracket	2 lbs.
3 8866	Fire Extinguisher	6 lbs.
4 8877-3	Practice Holder	4 lbs.
5 96901-3-01	Hinge Kit with lockable latch	4 lbs.
6 96903-3-01	Solid Panel Kit	10 lbs.

PAGE 15

MORE RED ZONE ACCESSORIES

# ADJUSTABLE SHELVING

## 17° TAPERED END PANEL CLOSER FIT

for more working space inside the van

## DEEP FULLY HEMMED SHELVES

sized for tools, equipment, and other materials

## EASY TO CUSTOMIZE

with pre-punched mounting holes for WEATHER GUARD® accessories and cabinets

## EASY TO ASSEMBLE AND "STALL"

with captive nuts on each shelf and complete "stallation" hardware

**WEATHER GUARD® EXCLUSIVE!**



## ADJUSTABLE DIVIDERS

Includes pack of four adjustable dividers for each shelf

## PUNCHED SHELVES

for easier "stallation" of accessory cabinets

## FRONT FLOOR CLEARANCE (16" SHELVES ONLY)

for material storage. Fits PACK RAT® Drawer Units

## UNMATCHED DURABILITY

achieved with heavy duty 18 gauge steel construction

## FLAT FRONTS

on 13-1/2" deep adjustable shelves. Mount doors and accessories at floor level

## Shelf Units: Ships complete in one carton

MODEL	HEIGHT	WIDTH	DEPTH	SHELVES	DIVIDERS	WEIGHT
9333-3-03	34"	36"	13½"	2	8	48 lbs.
9334-3-03	34"	42"	13½"	2	8	48 lbs.
9335-3-03	34"	52"	13½"	2	8	72 lbs.
9336-3-03	34"	60"	13½"	2	8	70 lbs.
9343-3-03	44"	36"	16"	3	12	74 lbs.
9344-3-03	44"	42"	16"	3	12	80 lbs.
9345-3-03	44"	52"	16"	3	12	85 lbs.
9346-3-03	44"	60"	16"	3	12	104 lbs.
<b>NEW!</b> 9352-3-03	44"	28"	13½"	3	12	50 lbs.
9353-3-03	44"	36"	13½"	3	12	53 lbs.
9354-3-03	44"	42"	13½"	3	12	57 lbs.
9355-3-03	44"	52"	13½"	3	12	66 lbs.
9356-3-03	44"	60"	13½"	3	12	73 lbs.
9363-3-03	60"	36"	16"	4	16	92 lbs.
9364-3-03	60"	42"	16"	4	16	94 lbs.
9365-3-03	60"	52"	16"	4	16	110 lbs.
9366-3-03	60"	60"	16"	4	16	136 lbs.
9373-3-03	60"	36"	13½"	4	16	76 lbs.
9374-3-03	60"	42"	13½"	4	16	94 lbs.
9375-3-03	60"	52"	13½"	4	16	110 lbs.
9376-3-03	60"	60"	13½"	4	16	136 lbs.

## 24" Deep Jumbo Shelving Items

Extra deep 24" shelving constructed of 18-gauge steel and finished with durable brite white powder coat. These shelves are easy to assemble and provide the perfect foundation for a customized van or trailer. Special order only, with longer lead times.



MODEL	HEIGHT	WIDTH	DEPTH	SHELVES
8393-3-01	59½"	42¼"	24"	3
8394-3-01	59½"	51¼"	24"	3
8395-3-01	59½"	69¼"	24"	3
8118-3-01	Short Bin Dividers for 24"D Shelves			

**NEW ITEMS AVAILABLE JUNE 2018**



# SECURE STORAGE

Add extra security and theft-resistance for valuable tools and equipment with WEATHER GUARD® Secure Storage shelf units. Multiple door and drawer modules easily assemble into REDZONE Shelving. Our welded steel construction and heavy-duty locking mechanism ensures peace of mind on the job or in the parking lot.

Select the shelf unit to fit your van, then the storage module to fit your needs.

## Secure Storage Shelf Units (42" Wide)

MODEL		HEIGHT	DIVIDERS	WEIGHT
9381-3-03	Full Size Vans	44"	8	104 lbs.
<i>Includes end panel and top shelf for secure storage unit</i>				
9391-3-03	High Roof Vans	60"	12	108 lbs.
<i>Includes end panels, top and center shelf for secure storage unit</i>				
9040-3-01	Door Module			47 lbs.
9045-3-02	5 Drawer Module			78 lbs.

## Secure Storage Service Parts

MODEL	DESCRIPTION	WEIGHT
70206-xx	Replacement Lock Kit	117 lbs.
70210-xx	Key Kit	1 lb.
70211-xx	Replacement D Handle Kit	1 lb.

xx- Designates key code. Specify key code 11-20 when ordering



Door Module  
9040-3-01



5 Drawer  
Module  
9045-3-02

**NEW!**

## SHELVING MOUNTING KITS



**UNIQUE 4-WAY STOP**  
*restricts movement*

**SECURE INSTALLATION**  
*evens out load spread*

**OPEN FLOOR MOUNT**  
*no floor rail to get in the way*



**STEEL MOUNTING PLATES**  
*distributes shelf load*

**MOUNTS TO EXISTING HOLES**

**FAST INSTALLATION**  
*no drilling needed*

### Sprinter Shelving Mounting Kit

- Unique 4-way stop combines mounting straps with steel brackets to resist front and back and side to side movement
- Secure installation - upper extruded aluminum rail spreads load across van wall
- Patent pending twist plates for easier shelf placement along van wall
- Open floor mounting - no floor rail to interfere with wide or bulky items under the bottom shelf

MODEL	DESCRIPTION	WEIGHT
975301-3-01	144" WB Mounting Kit	19 lbs.
975302-3-01	170" WB Mounting Kit	25 lbs.

### Metris Shelving Mounting Kit

- Heavy gauge steel mounting plates distribute shelf load and provide secure mounting to van interior
- Kit mounts shelf units directly to reinforced weld nuts or factory holes in the van without drilling new holes
- Faster installation with reduced risk of damage to van

MODEL	DESCRIPTION	WEIGHT
9753-3-01	Metris Van Shelving	13 lbs.



# ACCESSORIES



## Shelf Doors with High Security D Handle Lock

Mount to shelf units or to retainer lips. Single point D-handle lock for added security. Allow seven mounting holes shelf to shelf spacing

MODEL	HEIGHT	SHELF WIDTH	WEIGHT
<b>NEW!</b> 9502-3-01	11"	28"	10 lbs.
9503-3-01	11"	36"	13 lbs.
9504-3-01	11"	42"	17 lbs.
9505-3-01	11"	52"	21 lbs.
9506-3-01	11"	60"	25 lbs.

## Light Weight Shelf Back Panels

Use with shelf doors to turn a shelf into a cabinet

MODEL	HEIGHT	SHELF WIDTH	WEIGHT
<b>NEW!</b> 9602-3-02	7¾"	28"	2 lbs.
9603-3-02	7¾"	36"	2 lbs.
9604-3-02	7¾"	42"	3 lbs.
9605-3-02	7¾"	52"	4 lbs.
9606-3-02	7¾"	60"	5 lbs.
<b>NEW!</b> 9602-3-01	14½"	28"	4 lbs.
9603-3-01	14½"	36"	4 lbs.
9604-3-01	14½"	42"	6 lbs.
9605-3-01	14½"	52"	8 lbs.
9606-3-01	14½"	60"	10 lbs.

## Retainer Lips

Keeps items in place under shelf units

MODEL	HEIGHT	SHELF WIDTH	DEPTH	WEIGHT
<b>NEW!</b> 9702-3-02	1½"	28"	1½"	1 lb.
9703-3-02	1½"	36"	1½"	1 lb.
9704-3-02	1½"	42"	1½"	1 lb.
9705-3-02	1½"	52"	1½"	2 lbs.
9706-3-02	1½"	60"	1½"	2 lbs.

## End Panels

Can't find the shelf combination you need? Configure your own shelf system with end panels and accessory shelves.

MODEL	HEIGHT	WIDTH	DEPTH	WEIGHT
9243-3-01	36"	2"	13½"	22 lbs.
9244-3-01	44"	2"	13½"	18 lbs.
9246-3-01	60"	2"	13½"	33 lbs.
9274-3-01	44"	2"	16"	30 lbs.
9276-3-01	60"	2"	16"	34 lbs.

## Extra Shelves

Includes one set of dividers

MODEL	HEIGHT	WIDTH	DEPTH	WEIGHT
<b>NEW!</b> 9142-3-01	2"	28"	13½"	10 lbs.
9143-3-01	2"	36"	13½"	14 lbs.
9144-3-01	2"	42"	13½"	18 lbs.
9145-3-01	2"	52"	13½"	22 lbs.
9146-3-01	2"	60"	13½"	26 lbs.
9163-3-01	2"	36"	16"	14 lbs.
9164-3-01	2"	42"	16"	18 lbs.
9165-3-01	2"	52"	16"	22 lbs.
9166-3-01	2"	60"	16"	26 lbs.



## Locking Storage & CATV Cabinets

MODEL	SHELVES	HEIGHT	WIDTH	DEPTH	WEIGHT
<b>1</b> 9020-3-01	N/A	22"	18"	16"	25 lbs.
<b>2</b> 9021-3-01	2*	22"	18"	16"	35 lbs.

\*Removable Shelves



## Bin Sets

Sturdy plastic bins sized to fit 16" or 13" deep adjustable van shelving

MODEL	HEIGHT	WIDTH	DEPTH	BINS	WEIGHT
9854-7-01	5"	5½"	14¾"	9	8 lbs.
9855-7-01	7"	8¼"	14¾"	6	10 lbs.
9856-7-01	7"	16½"	14¾"	3	8 lbs.
9858-7-01	5"	5½"	10⅞"	6	8 lbs.
9859-7-01	7"	7"	10⅞"	6	8 lbs.



Model 89011

## Van Floor Mats

Floor mats protect the van floor from normal wear and tear, prevent cargo from shifting, and reduce noise.

MODEL	VAN TYPE	WEIGHT
89011	70" x 127" Rectangular Mat*	55 lbs.

NEW ITEMS AVAILABLE JUNE 2018



# ACCESSORIES

## CAB COMMAND CENTER !



**WEATHER GUARD® EXCLUSIVE!**



### Cab Command Center for Sprinter

MODEL	HEIGHT	WIDTH	DEPTH	WEIGHT
9012-3-01	12"	13"	20"	30 lbs.

**RAISED MOUNTING BASE FOR 7" FLOOR CLEARANCE**  
with tamper-resistant Torx® head mounting bolts

**! POWER PASS® ELECTRICAL PASS-THRU GROMMET**  
allows you to charge items within the box

**SECURE D HANDLE LOCKS**  
single point latching for theft-resistance

**SIMPLIFIED INSTALLATION**  
gets you back on the job quickly



### Floor Mounted Accessories

MODEL	DESCRIPTION	HEIGHT	WIDTH	DEPTH	WEIGHT
1	9861-3-01 Cable Spool Holder	42½"	19¾"	16¼"	37 lbs.
2	9862-3-01 3-50 lb. Tank Holder	45½"	15½"	8"	31 lbs.
3	9863-3-01 2-30 lb., 1-50 lb. Tank Holder	40"	15½"	8"	27 lbs.
4	9864-3-01 4-30 lb. Tank Holder	48½"	13"	8"	31 lbs.
5	9860-3-01 Catalog File Unit	36"	6"	12"	16 lbs.
6	9885-7-01 5 Gal. Bucket Holder	6¼"	11¼"	11¼"	8 lbs.



**LIMITED QUANTITIES!**

### Door Trays and Literature Holders

MODEL	HEIGHT	WIDTH	DEPTH	WEIGHT	
1	9871-3-01	21¾"	20¼"	4⅝"	19 lbs.
2	9872-3-01	21¾"	20¼"	4⅝"	18 lbs.
3	9873-3-01	21¾"	20¼"	4⅝"	19 lbs.
4	9880-3-01	16"	13"	5"	11 lbs.

# REDZONE ACCESSORIES

Looking for parts and supplies won't slow you down with new and re-engineered REDZONE van storage accessories. Organizers and holders keep frequently used items in easy reach for maximum productivity. Tool cabinets, parts bin boxes, and locking storage keep small components organized.

**CUSTOMIZED ORGANIZATION**  
for supplies and tools

**HEAVY DUTY 18 GAUGE STEEL CONSTRUCTION**  
makes for tough, long lasting accessories

**POWDER COAT FINISH**  
provides durability

**EASY TO INSTALL**  
to shelf end panels, bulkheads, and door



## HOOKS AND BRACKETS



## REDZONE Accessories

	MODEL	DESCRIPTION	HEIGHT	WIDTH	DEPTH	WEIGHT
1	9874-7-01	Can Organizer	9.8"	12"	4"	3 lbs.
2	9879-7-01	Tool Organizer	5½"	15"	4"	3 lbs.
3	9881-7-01	Caulk Tube Tray	7½"	13½"	7½"	4¼ lbs.
4	9882-7-01	Wire Spool Holder End Mount	26"	14"	6"	12 lbs.
5	9883-7-01	Large Parts Bin	11"	13"	7"	10 lbs.
6	9884-7-01	Medium Parts Bin	6½"	13"	7"	8 lbs.
7	9885-7-01	5 Gallon Bucket Holder	6¼"	11¼"	11¼"	8 lbs.
8	9886-7-01	30# Refrigerant Tank Holder	10¾"	9¾"	9¾"	9 lbs.
9	9887-7-01	Ladder Holder	4"	1½"	3½"	¼ lb.
10	9891-7-01	Large Hook (5" diameter)	8"	1¾"	5"	½ lb.
11	9892-7-01	2 Hook Holder (5" diameter)	8"	9"	5"	½ lb.
12	9893-7-01	3 Hook Cord or Tool Holder	5¼"	9"	4½"	½ lb.

# CABINETS



## Mechanics Grade Tool Cabinets

High quality and durable mechanics-grade Tool Cabinets for your van feature easy-to-grip handles, smooth ball-bearing rollers, latches for each drawer, and secure locks that can be keyed alike. Bin Cabinets feature hook and loop fasteners to securely hold bins in place.

	MODEL	DRAWERS	HEIGHT	WIDTH	DEPTH	WEIGHT
1	9912-3-02	2	12"	16"	13.7"	26 lbs.
2	9914-3-02	4	12"	16"	13.7"	32 lbs.
3	9924-3-02	4	24"	16"	13.7"	48 lbs.
4	9928-3-02	8	24"	16"	13.7"	60 lbs.
5	9984-3-01	4	24"	18"	13.7"	53 lbs.
6	9988-3-01	8	24"	18"	13.7"	60 lbs.

## Cabinet Divider Kits

	MODEL	DESCRIPTION	WEIGHT
	9822-3-01	Divider and Liner Kit for 9914-3-02, 9928-3-02	2 lbs.
	9824-3-01	Divider and Liner Kit for 9912-3-02, 9924-3-02	2 lbs.



## Parts Boxes & Bin Cabinets

	MODEL	BINS	HEIGHT	WIDTH	DEPTH	WEIGHT
1	9906-3-02	6	4½"	32½"	11¾"	18 lbs.
2	9909-3-02	9	12"	17"	11¾"	28 lbs.
3	9918-3-02	18	12"	32½"	11¾"	54 lbs.
4	9950-7-02*	N/A	12.6"	20.3"	14.4"	4 lbs.
5	9951-9-01	N/A	3"	18½"	13"	3 lbs.
Special Order Cabinets (Call for availability. Longer lead time required)						
6	8908-3	8	8½"	22 "	11¾"	24 lbs.

\*Parts cases not included



1 Invert shelf when assembling it and mount cabinet directly to shelf.

2 Keep shelf facing up and use Cabinet Mounting Spacer kit Model 9994. Order separately.

## Cabinet Accessory Mounting

The new van shelf design includes cabinet mounting holes that make it easier to assemble and install. There are two fast ways to mount cabinet and parts boxes to van shelves.

	MODEL	DESCRIPTION	WEIGHT
	9994	Shelf Cabinet Mounting Kit	1 lb.
	9996-3-01	Shelf Accessory Mounting Kit (16")	1 lb.



# DRAWER UNITS

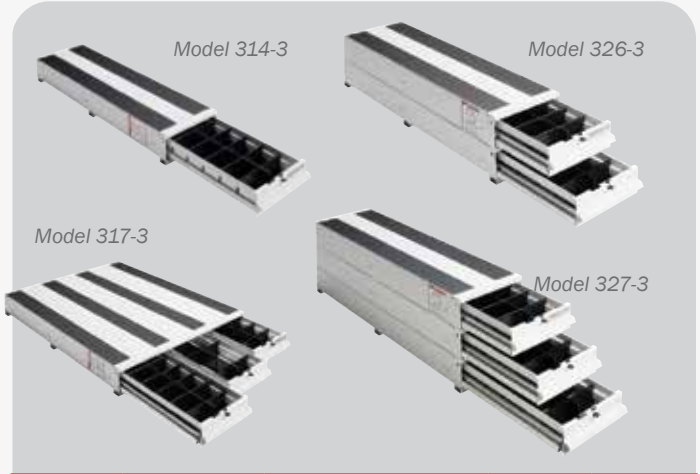
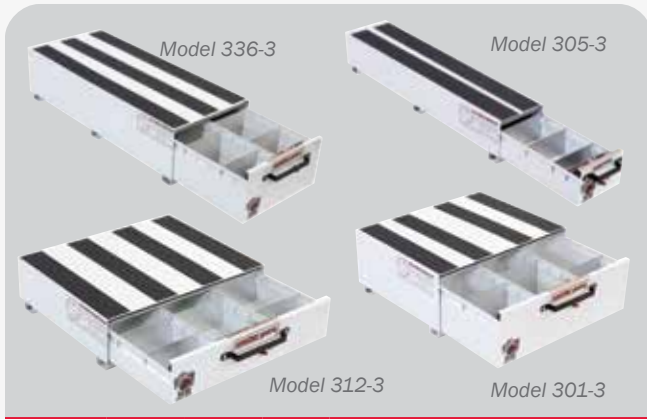

## PACK RAT® Drawer Units

MODEL	HEIGHT	WIDTH	DEPTH	COMPARTMENTS	DIVIDERS	WEIGHT
<b>STEEL DRAWER UNITS</b>						
301-3	12½"	30"	24"	3	12	169 lbs.
303-3	12½"	39¾"	24"	4	12	217 lbs.
304-3	9"	30"	48"	2	6	220 lbs.
305-3	9"	10¼"	48"	1	6	106 lbs.
306-3	9"	20"	48"	2	12	179 lbs.
307-3	9"	30"	48"	3	18	247 lbs.
308-3	9"	39¾"	48"	4	24	322 lbs.
308-5	9"	39¾"	48"	4	24	322 lbs.
312-3	9"	30"	24"	3	12	151 lbs.
334-3	12½"	30"	48"	2	6	245 lbs.
335-3	12½"	10¼"	48"	1	6	130 lbs.
336-3	12½"	20"	48"	2	12	210 lbs.
337-3	12½"	30"	48"	3	18	294 lbs.
338-3	12½"	39¾"	48"	4	24	383 lbs.
338-5	12½"	39¾"	48"	4	24	383 lbs.
<b>ALUMINUM DRAWER UNITS</b>						
310-3-01	14½"	11¾"	42"	1	0	56 lbs.

## ITEMIZER® Drawer Units

These storage solutions conveniently increase your storage space by placing small equipment at your fingertips without the need to crawl inside the van. Drawer dividers provide an extensive array of organizing options.

- Lightweight Aluminum Drawers carry up to 75 lbs. each
- Units Can be stacked as needed for additional storage
- Roller mounted drawers glide open to full extension
- Adjustable drawer dividers offer greater flexibility
- Anti-Skid Strips provide traction for wet and muddy boots

MODEL	DRAWERS	HEIGHT	WIDTH	DEPTH	WEIGHT
314-3	1	6¾"	12¼"	49"	26 lbs.
316-3	2 Lateral	6¾"	24"	49"	55 lbs.
317-3	3 Lateral	6¾"	36"	49"	85 lbs.
318-3	4 Lateral	6¾"	48"	49"	110 lbs.
326-3	2 Stacked	12¼"	12¼"	49"	48 lbs.
327-3	3 Stacked	17¾"	12¼"	49"	71 lbs.
328-3	4 Stacked	23½"	12¼"	49"	92 lbs.

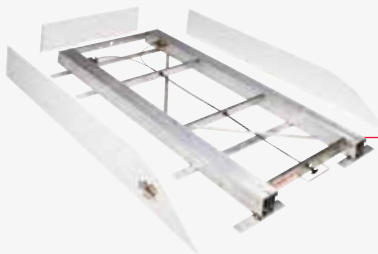

**FOR FULL-SIZE VAN & MINIVAN REAR DOOR**

Model 3200

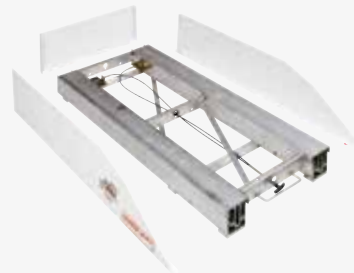

**FOR FULL-SIZE VAN SIDE DOOR**

Model 3100

**FOR LONG WHEEL BASE FULL-SIZE VAN REAR DOOR**

Model 3400

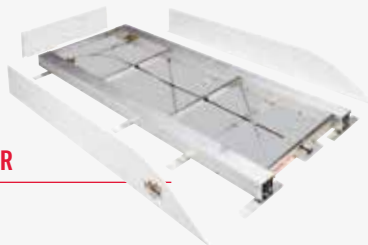

## BED RAT® Sliding Platforms

MODEL	HEIGHT	WIDTH	DEPTH	WEIGHT
3100	4¾"	22"-44¾"	54"	97 lbs.
3200	4¾"	44¾"	68"	123 lbs.
3400	4¾"	44¾"	90"	155 lbs.

# EZGlide2™ DROP-DOWN LADDER RACK



**EASIEST TO OPERATE**  
50% less effort to operate than competitor drop-down ladder racks, reducing strain on the operator

**LIGHTEST WEIGHT**  
Drop-down ladder rack available

- Maximize fuel economy
- Maximize carrying capacity

**MOST VERSATILE**

- Up to 40' extension ladders
- 3' - 10' stepladders
- Conduit carriers

STEP 1

## CHOOSE A MOUNTING KIT (Mounting Kit not needed for Ford E-Series - Go to Step 2)

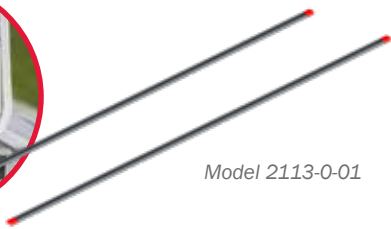

Model 2113-0-01

### Mounting Channel Kits

All Mounting Channel Kits attach to factory mounting points. No drilling required. All hardware included.

MODEL	DETAILS	WEIGHT
2113-0-01	Mounting Channel Kit - Sprinter	15 lbs.
2085-0-01	Mounting Channel Kit - Metris Compact	15 lbs.

STEP 2

## SELECT A DROP-DOWN LADDER RACK ASSEMBLY (Single-Side Only with Crossmembers)

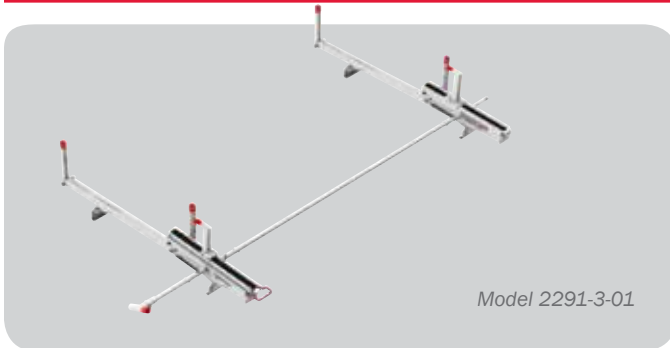

Model 2291-3-01

### Drop-Down Ladder Rack Assemblies

Drop-down can mount on driver or passenger side. Rack fits 16' to 40' Extension, 5' to 10' Step and 3' to 8' Podium, evenly distributed on ladder rack. Carry ladders appropriate to the size of the vehicle.

MODEL	DETAILS	WEIGHT
2291-3-01	Extended Drop-Down - Mid-Roof or High-Roof <i>(Includes two 70" Cross Members which can be set at 96" or 77" center to center)</i>	77 lbs.
2261-3-01	Fixed Drop-Down - Compact <i>(Includes two 60" Cross Members which can be set at 77" center to center)</i>	83 lbs.

Always properly secure ladders to the ladder rack while driving. Transporting ladders longer than the vehicle is not recommended.

## KITS AND ACCESSORIES

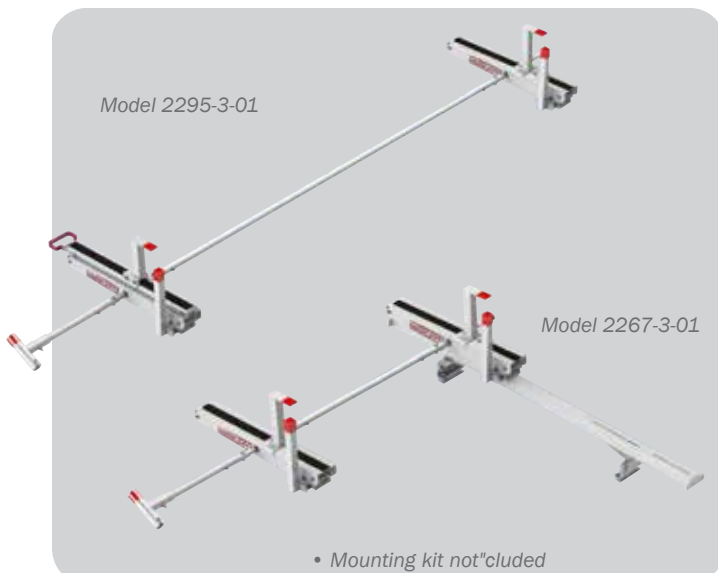

Model 2295-3-01

Model 2267-3-01

• Mounting kit not included

### Dual Drop-Down Ladder Rack Accessories

MODEL	DETAILS	WEIGHT
2295-3-01	Extended Drop-Down Long Ladder Kit - Mid-Roof/High-Roof <i>(Cross Members not included)</i> Installs to 2291-3-01	48 lbs.
2297-3-01	Extended Drop-Down Short Ladder Kit - Mid-Roof/High-Roof <i>(Includes one 70" Cross Member which can be set at 42" center to center)</i> Installs to 2291-3-01	55 lbs.
2265-3-01	Fixed Drop-Down Long Ladder Kit - Compact <i>(Cross Members not included)</i>	58 lbs.
2267-3-01	Fixed Drop-Down Short Ladder Kit - Compact <i>(Includes one 60" Cross Member which can be set at 42" center to center)</i> Installs to 2261-3-01	61 lbs.
<b>NEW!</b> 2254D-3-01	Quick Clamp Add-on Kit - Driver Side	6 lbs.
<b>NEW!</b> 2254P-3-01	Quick Clamp Add-on Kit - Passenger Side	6 lbs.
2060-3-01	Accessory Cross Member - Compact (60" wide)	6 lbs.
2070-3-01	Accessory Cross Member - Full Size (70" wide)	6 lbs.

# VAN LADDER RACKS

WEATHER GUARD® Roof Racks are designed to mount through holes built into the MercedesMetris and Sprinter Vans. Roof rack mounting kit includes stands and hardware to improve rooftop mounting.

## STEP 1 CHOOSE A MOUNTING KIT

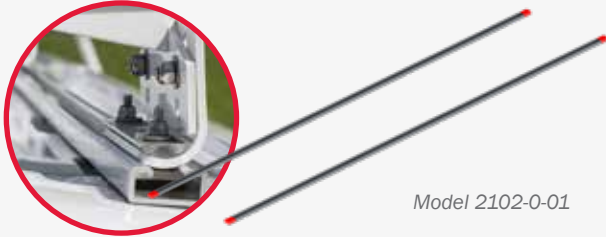

### Mounting Channel Kits

All Mounting Channel Kits attach to factory mounting points. No drilling required. All hardware included.

MODEL	DETAILS	WEIGHT
2113-0-01	Mounting Channel Kit - Sprinter	15 lbs.
2085-0-01	Mounting Channel Kit - Metris Compact	15 lbs.

## STEP 2 SELECT VAN RACK AND ACCESSORY CROSS MEMBERS



### Powder Coated Aluminum Rack for Sprinter

MODEL	DETAILS	WEIGHT
209-3-03	70" All Purpose Rack	35 lbs.
2097-3-03	70" All Purpose Accessory Cross Member	19 lbs.



### Aluminum All Purpose Racks for Metris

MODEL	DETAILS	WEIGHT
218-3-03	60" All Purpose Rack	31 lbs.
222-3-03	60" All Purpose Accessory Cross Member	17 lbs.

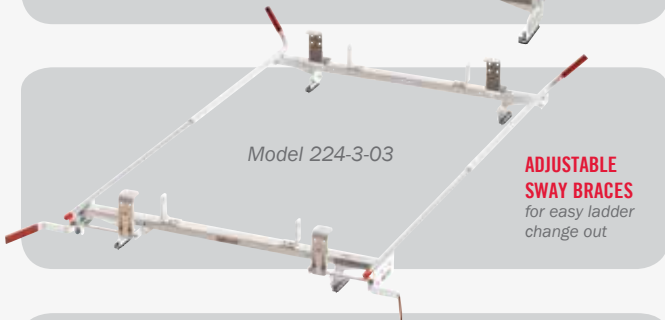

### ! Quick Clamp Racks for Metris

MODEL	DETAILS	WEIGHT
223-3-03	60" Single Quick Clamp Rack (curb-side only)	44 lbs.
224-3-03	60" Dual Quick Clamp Rack	54 lbs.
225-3-03	60" Quick Clamp Accessory Cross Member	16 lbs.



### Sliding Ladder Racks

Our Sliding Ladder Rack provides quick and easy ladder storage inside your van. Rugged and durable, this rack fits up to 8-foot step, extension ladders when mounted to the roof.

MODEL	DETAILS	WEIGHT
250	Sliding Ladder Rack	27 lbs.

# CONDUIT CARRIERS



### Aluminum Conduit Carrier

Keep your conduit safe, secure, and clean with our lightweight and durable Conduit Carrier.

MODEL	DETAILS	LENGTH	WIDTH	HEIGHT	WEIGHT
237	Conduit Carrier	121½"	11"	6"	40 lbs.
238	Extension	6"	11"	6"	4 lbs.
239	PVC Conduit Carrier Kit				4 lbs.



## MERCEDES / FREIGHTLINER / DODGE SPRINTER

The dimensions show in this guide refer to model year 2007-2018 Sprinter NV vans. Always measure your van carefully to make sure that the equipment you choose will fit properly. Verify the location of the gas tank, brake lines, wiring harness, etc. before installing any equipment. Shelving Mounting Kits are recommended. Do not exceed the van manufacturer's roof load rating.

- 170" Extended Wheel Base
- 170" Wheel Base
- 144" Wheel Base

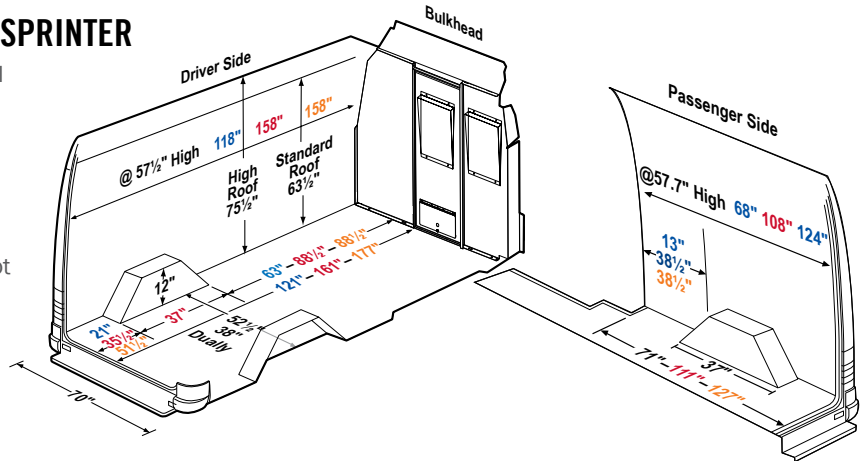

## MERCEDES METRIS

The dimensions show in this guide refer to model year 2018 and earlier Mercedes Metris vans. Always measure your van carefully to make sure that the equipment you choose will fit properly. Verify the location of the gas tank, brake lines, wiring harness, etc. before installing any equipment. Shelving Mounting Kits are recommended. Do not exceed the van manufacturer's roof load rating.

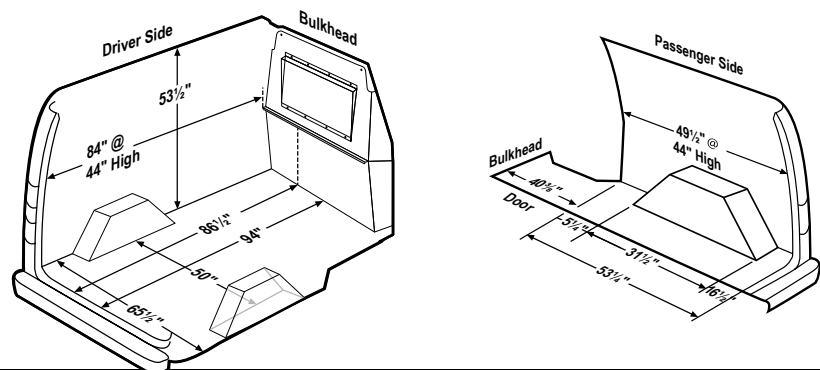

Always measure your van carefully to make sure that the equipment you choose will fit properly. Verify the location of the gas tank before installing any equipment. Shelving Mounting Kits are recommended. Do not exceed the van manufacturer's roof load rating.



### LIMITED LIFETIME WARRANTY

Knaack LLC (the Manufacturer) warrants to the original purchaser, only, that WEATHER GUARD® van products (the "WEATHER GUARD Product") will be free from defects in material and workmanship from the date of purchase and continuing for the expected lifetime of the WEATHER GUARD Product. Please call our customer service department toll free at 1.800.456.7865 with any questions or comments.

DO NOT use these products for storing or transporting flammables, explosives, hazardous materials or waste, such as gasoline, solvents, gun powder, dynamite, gases or any tanks, torches or gas powered equipment. These products are intended and safe for storing and transporting small tools and other non-combustible, non-flammable materials. Any modification made to, or unintended use of, these products may create a dangerous condition causing death, serious bodily injury or property damage.

#### NOTICE

Any modification or unintended use of these products shall immediately void all manufacturers warranties. Manufacturer disclaims all liability for injuries to persons or property resulting from any modification to, or unintended use of these products.

Ford Transit Connect, Nissan NV, Mercedes Sprinter, and Dodge Ram CV are registered trademarks of their respective owners.

For information on the WEATHER GUARD® Van Solutions Limited Lifetime Warranty, visit [www.weatherguard.com](http://www.weatherguard.com)  
To order more WEATHER GUARD® Van Solutions OEM brochures, please call us at **800.456.7865**



©2018 Knaack, LLC. All rights reserved.

CONTACT YOUR LOCAL DISTRIBUTOR/UPFITTER