

2018 VAN STORAGE EQUIPMENT



# RAM VAN SOLUTIONS

FOR PROMASTER® AND PROMASTER CITY™ VANS



**RAM**



[WWW.WEATHERGUARD.COM](http://WWW.WEATHERGUARD.COM)

# **weather guard** DESIGNED WITH THE PROFESSIONAL IN MIND

WEATHER GUARD® Van Solutions deliver unmatched organization, productivity, and durability, backed by a Limited Lifetime Warranty.



WEATHER GUARD® Van Solutions are ready to roll with game changing improvements based on years of research and your input. Completely retooled shelving, improved bulkheads, customizable organizational features, and a host of smart new accessories, designed around the common sense idea that tools and equipment belong on the shelf, not the floor.



The fast lane for small business.

Check out RAM's Business Link program and receive upfit assistance cash from RAM on Weather Guard Interiors and Roof Racks for your new RAM van! Eligible commercial customers will receive up to \$1,000 on upfits valued at \$1,000 or more with the purchase or lease of any new Promaster cargo van; and up to \$500 on upfits valued at \$500 or more, with the purchase or lease of any new Promaster City cargo van. A local Weather Guard upfitter will complete the installation for you.

*Incentives may change without notice. See your local RAM dealer for full program details. Incentive details are different in Canada.*

## TABLE OF CONTENTS

- BASE PACKAGES.....4-13**
  - Mid-Roof, 118" WB..... 4-5
  - Mid/High-Roof, 136" WB ..... 6-7
  - High-Roof, 159" WB ..... 8-9
  - High-Roof, 159" WB, Extended Length..... 10-11
  - ProMaster City ..... 12-13
- BULKHEADS .....14**
- ADJUSTABLE SHELVING .....15**
- SECURE STORAGE .....16**
- ACCESSORIES .....17**
- CABINETS .....18**
- DRAWER UNITS.....25**
- ROOF RACKS.....26-27**

The PRO PACKAGES for RAM ProMaster and ProMaster City vans on the next few pages can be used as a complete upfit package or a starting point for a custom upfit. Van layout dimensions are on the back cover if you're looking for something more custom or just need some detailed information about your van's interior. If you need more help, your local WEATHER GUARD® Truck and Van Equipment distributor is a great resource for all your upfitting questions.

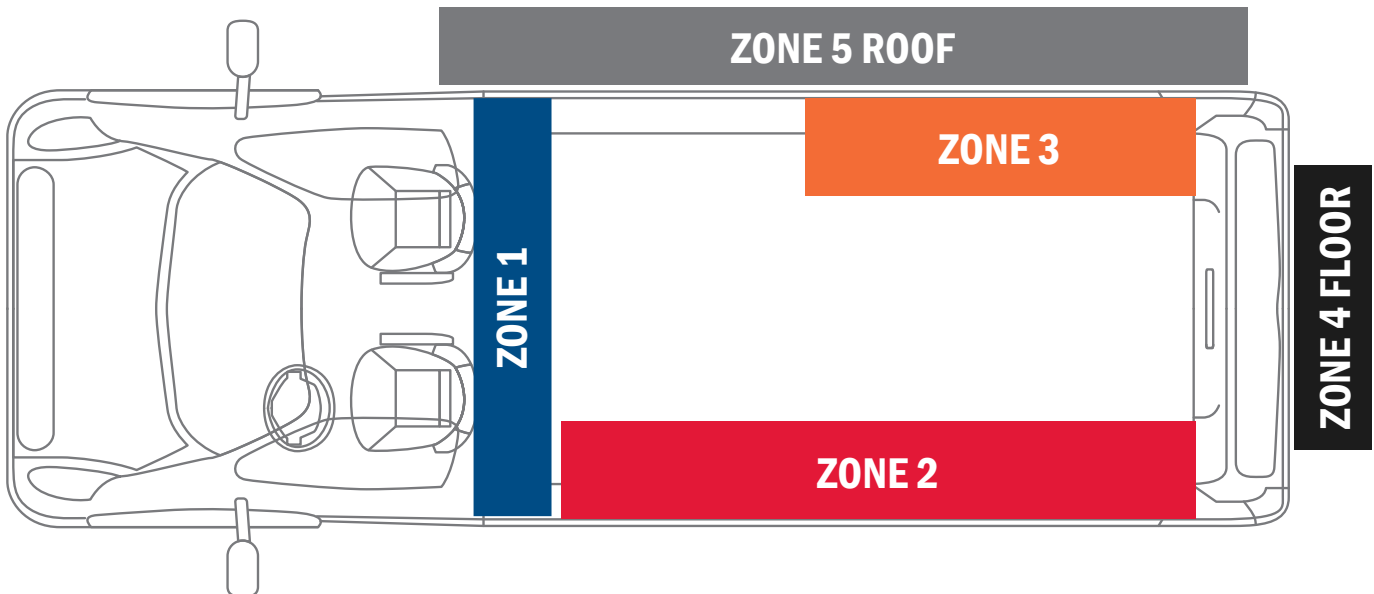

# LOW ROOF PACKAGES 118" WHEEL BASE



From contractors to plumbers and electricians, we know that hard working professionals need flexibility to fit a new van to the job. These packages are customizable for your needs now or in the future with shelving and accessories starting on page 15.

**NEW!**

## ProMaster Low Roof Mounting Kit

- Heavy gauge steel mounting plates distribute shelf load and provide secure mounting to van interior
- Mounts directly to reinforced weld nuts and cargo tie-downs or into existing holes (no drilling)
- Faster installation with reduced risk of damage to van during installation

MODEL	DESCRIPTION	WEIGHT
975201-3-01	RAM Promaster 118" WB LR Mounting Kit	18 lbs.

## COMMERCIAL / BASE

DRIVER SIDE

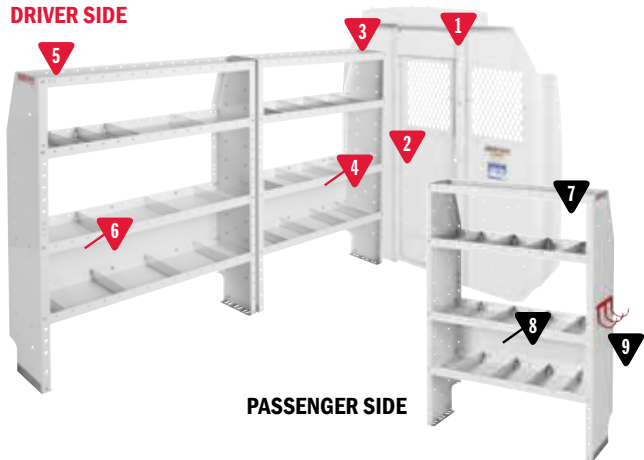

PASSENGER SIDE

## 600-8440S Commercial Shelving Package

MODEL	DESCRIPTION	QUANTITY
1	96142-3-01 Screen Bulkhead - ProMaster®	1
2	96901-3-01 Swing Door Conversion Kit	1
3	9373-3-03 Adjustable 4 Shelf Unit (36" x 13½" x 60")	1
4	9603-3-01 Accessory Back Panel (for 36" Shelf Unit 14½" tall)	1
5	9374-3-03 Adjustable 4 Shelf Unit (42" x 60" x 13½")	1
6	9604-3-01 Accessory Back Panel (for 42" Shelf Unit 14½" tall)	1
7	9374-3-03 Adjustable 4 Shelf Unit (42" x 60" x 13½")	1
8	9604-3-01 Accessory Back Panel (for 42" Shelf Unit 14½" tall)	1
9	9893-7-01 REDZONE 3 Hook Cord or Tool Holder	1
*10	975201-3-01 Van Shelf Mounting Kit - Promaster 118" WB	1

\* Not Shown

## GENERAL SERVICE / CONTRACTOR

DRIVER SIDE

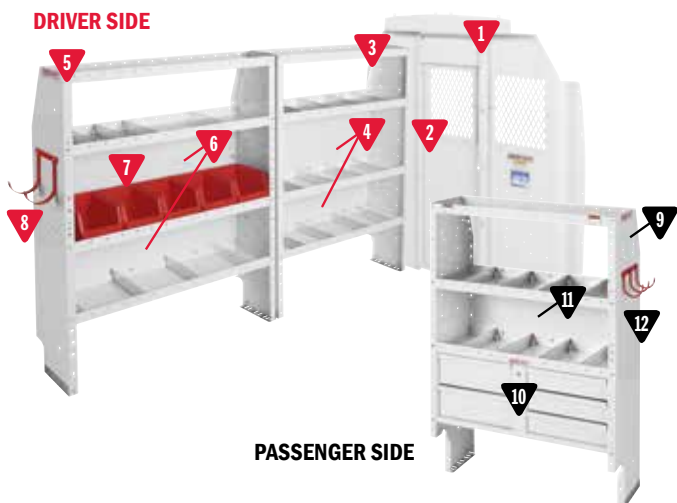

PASSENGER SIDE

## 600-8441S General Service/Contractor Package

MODEL	DESCRIPTION	QUANTITY
1	96142-3-01 Screen Bulkhead - ProMaster®	1
2	96901-3-01 Swing Door Conversion Kit	1
3	9373-3-03 Adjustable 4 Shelf Unit (36" x 60" x 13½")	1
4	9603-3-01 Accessory Back Panel (for 36" Shelf Unit 14½" tall)	2
5	9374-3-03 Adjustable 4 Shelf Unit (42" x 60" x 13½")	1
6	9604-3-01 Accessory Back Panel (for 42" Shelf Unit 14½" tall)	2
7	9859-7-01 REDZONE Medium 6 Bin Set (13")	1
8	9892-7-01 REDZONE 2 Hook Holder (5" diameter)	1
9	9391-3-03 Heavy Duty Shelf Unit (for Secure Storage Modules - 42" x 60" x 16")	1
10	9045-3-02 5 Drawer Secure Storage Module (42" x 17" x 16")	1
11	9604-3-01 Accessory Back Panel (for 42" Shelf Unit 14½" tall)	1
12	9893-7-01 REDZONE 3 Hook Cord or Tool Holder	1
*13	975201-3-01 Van Shelf Mounting Kit - Promaster 118" WB	1

\* Not Shown

## CABLE / PLUMBING

DRIVER SIDE

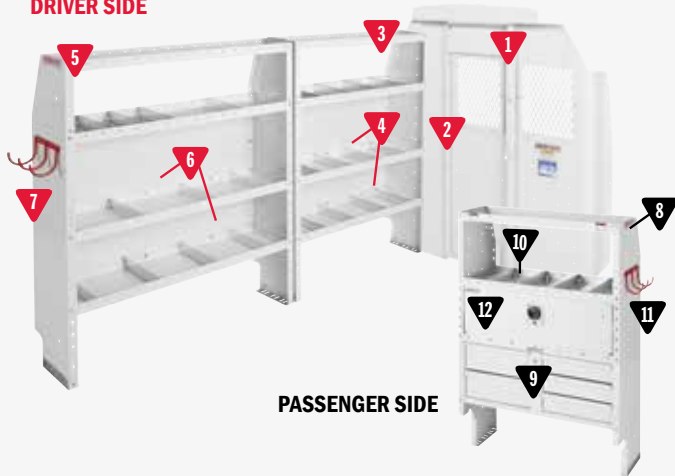

PASSENGER SIDE

### 600-8442S Cable/Plumber Package

MODEL	DESCRIPTION	QUANTITY
1	96142-3-01 Screen Bulkhead - ProMaster®	1
2	96901-3-01 Swing Door Conversion Kit	1
3	9373-3-03 Adjustable 4 Shelf Unit (36" x 60" x 13½")	1
4	9603-3-01 Accessory Back Panel (for 36" Shelf Unit 14½" tall)	2
5	9374-3-03 Adjustable 4 Shelf Unit (42" x 60" x 13½")	1
6	9604-3-01 Accessory Back Panel (for 42" Shelf Unit 14½" tall)	2
7	9893-7-01 REDZONE 3 Hook Cord or Tool Holder	1
8	9391-3-03 Heavy Duty Shelf Unit (for Secure Storage Modules - 42" x 60" x 16")	1
9	9045-3-02 5 Drawer Secure Storage Module (42" x 17" x 16")	1
10	9604-3-01 Accessory Back Panel (for 42" Shelf Unit 14½" tall)	1
11	9893-7-01 REDZONE 3 Hook Cord or Tool Holder	1
12	9504-3-01 Shelf Door (for 42" Shelf Unit)	1
*13	975201-3-01 Van Shelf Mounting Kit - Promaster 118" WB	1

\* Not Shown

## HVAC / MECHANICAL

DRIVER SIDE

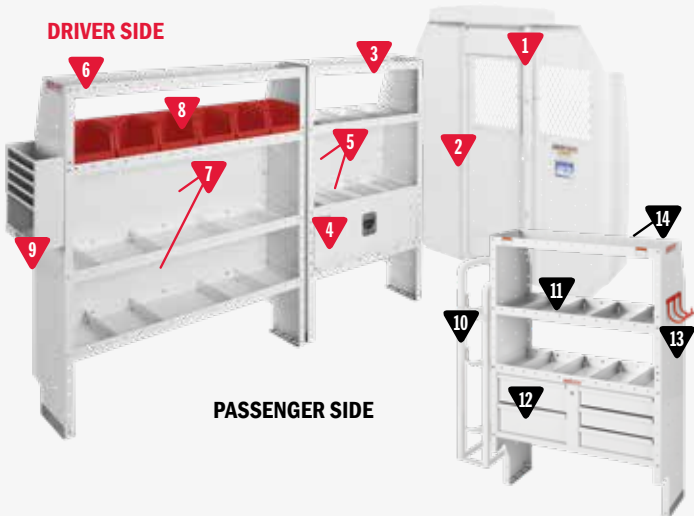

PASSENGER SIDE

### 600-8443S HVAC/Mechanical Package

MODEL	DESCRIPTION	QUANTITY
1	96142-3-01 Screen Bulkhead - ProMaster®	1
2	96901-3-01 Swing Door Conversion Kit	1
3	9373-3-03 Adjustable 4 Shelf Unit (36" x 60" x 13½")	1
4	9503-3-01 Shelf Door (for 36" Shelf Unit)	1
5	9603-3-01 Accessory Back Panel (for 36" Shelf Unit 14½" tall)	2
6	9374-3-03 Adjustable 4 Shelf Unit (42" x 60" x 13½")	1
7	9604-3-01 Accessory Back Panel (for 42" Shelf Unit 14½" tall)	2
8	9859-7-01 REDZONE Medium 6 Bin Set (13")	2
9	9880-3-01 Literature Holder 6 Compartment	1
10	9863-3-01 Refrigerant Tank Rack (2x 30#, 1x 50#)	1
11	9391-3-03 Heavy Duty Shelf Unit (for Secure Storage Modules - 42" x 60" x 16")	1
12	9045-3-02 5 Drawer Secure Storage Module (42" x 17" x 16")	1
13	9893-7-01 REDZONE 3 Hook Cord or Tool Holder	1
*14	975201-3-01 Van Shelf Mounting Kit - Promaster 118" WB	1

\* Not Shown

## ELECTRICAL

DRIVER SIDE

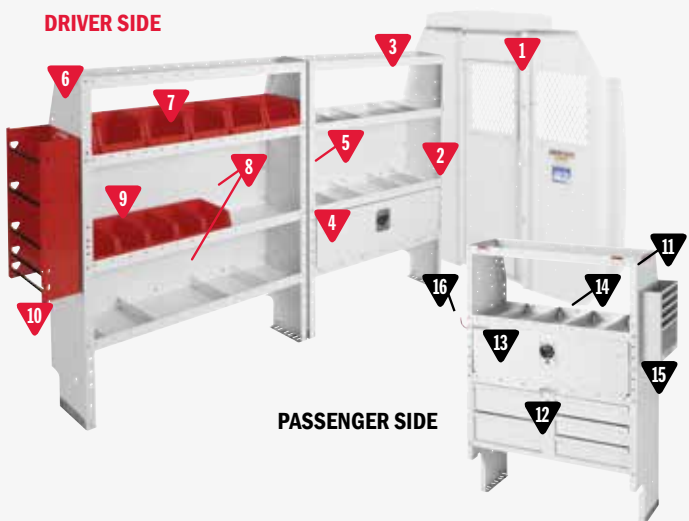

PASSENGER SIDE

### 600-8444S Electrical Package

MODEL	DESCRIPTION	QUANTITY
1	96142-3-01 Screen Bulkhead - ProMaster®	1
2	96901-3-01 Swing Door Conversion Kit	1
3	9373-3-03 Adjustable 4 Shelf Unit (36" x 60" x 13½")	1
4	9503-3-01 Shelf Door (for 36" Shelf Unit)	1
5	9603-3-01 Accessory Back Panel (for 36" Shelf Unit 14½" tall)	2
6	9374-3-03 Adjustable 4 Shelf Unit (42" x 44" x 13½")	1
7	9859-7-01 REDZONE Medium 6 Bin Set (13")	1
8	9604-3-01 Accessory Back Panel (for 42" Shelf Unit 14½" tall)	2
9	9858-7-01 REDZONE Small 6 Bin Set (13")	1
10	9882-7-01 REDZONE Wire Spool Holder End Mount	1
11	9391-3-03 Heavy Duty Shelf Unit (for Secure Storage Modules - 42" x 60" x 16")	1
12	9045-3-02 5 Drawer Secure Storage Module (42" x 17" x 16")	1
13	9504-3-01 Shelf Door (for 42" Shelf Unit)	1
14	9604-3-02 Accessory Back Panel (for 42" Shelf Unit 14½" tall)	2
15	9880-3-01 Literature Holder 6 Compartment	1
16	9893-7-01 REDZONE 3 Hook Cord or Tool Holder	1
*17	975201-3-01 Van Shelf Mounting Kit - Promaster 118" WB	1

\* Not Shown

# LOW / HIGH ROOF PACKAGES 136" WHEEL BASE

Our Pro Packages help you organize your equipment and supplies, large and small. From recipis, drills and hand tools to expensive test equipment, the packages are customizable to meet your specific storage needs with a wide range of accessories starting on page 17.



**NEW!**

## ProMaster Low/High Roof Mounting Kit

- Heavy gauge steel mounting plates distribute shelf load and provide secure mounting to van interior
- Mounts directly to reinforced weld nuts and cargo tie-downs or into existing holes (no drilling)
- Faster installation with reduced risk of damage to van during installation

MODEL	DESCRIPTION	WEIGHT
975202-3-01	Promaster 136" WB LR, HR Mounting Kit	17 lbs.

## COMMERCIAL / BASE

DRIVER SIDE

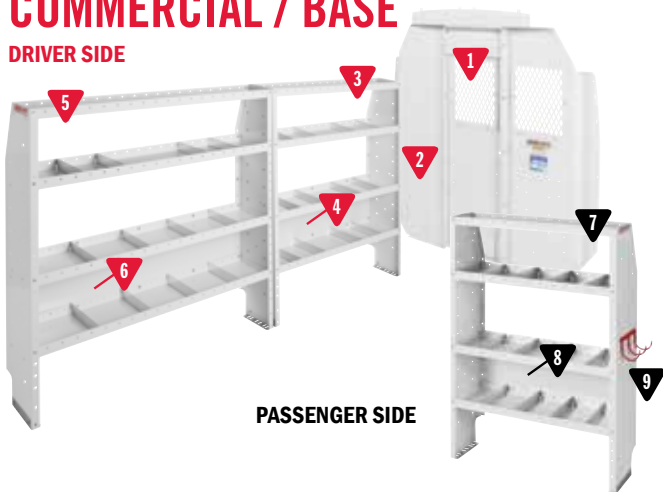

PASSENGER SIDE

## 600-8440R Commercial Shelving Package

MODEL	DESCRIPTION	QUANTITY
1	96142-3-01 Screen Bulkhead - ProMaster®	1
2	96901-3-01 Swing Door Conversion Kit	1
3	9374-3-03 Adjustable 4 Shelf Unit (42" x 60" x 13½")	1
4	9604-3-01 Accessory Back Panel (for 42" shelf unit 14½" tall)	1
5	9375-3-03 Adjustable 4 Shelf Unit (52" x 60" x 13½")	1
6	9605-3-01 Accessory Back Panel (or 52" shelf unit 14½" tall)	1
7	9375-3-03 Adjustable 4 Shelf Unit (52" x 60" x 13½")	1
8	9605-3-01 Accessory Back Panel (for 52" shelf unit 14½" tall)	1
9	9893-7-01 REDZONE 3 Hook Cord or Tool Holder	1
*10	975202-3-01 Van Shelf Mounting Kit - ProMaster 136" WB	1

\* Not Shown

## GENERAL SERVICE / CONTRACTOR

DRIVER SIDE

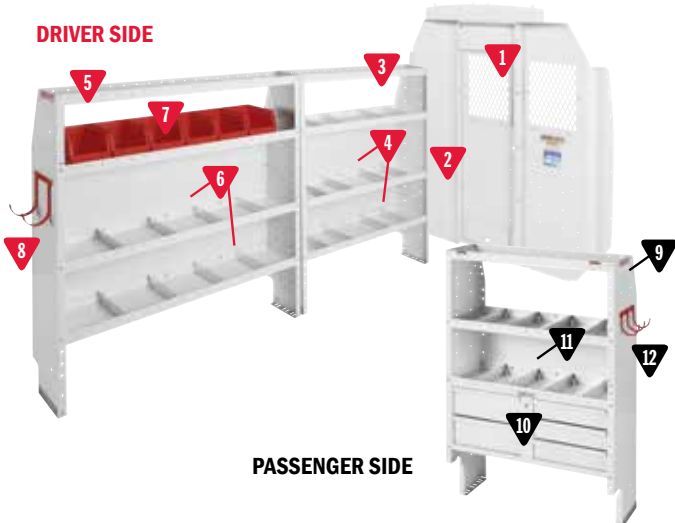

PASSENGER SIDE

## 600-8441R General Service/Contractor Package

MODEL	DESCRIPTION	QUANTITY
1	96142-3-01 Screen Bulkhead - ProMaster®	1
2	96901-3-01 Swing Door Conversion Kit	1
3	9374-3-03 Adjustable 4 Shelf Unit (42" x 60" x 13½")	1
4	9604-3-01 Accessory Back Panel (for 42" shelf unit 14½" tall)	2
5	9375-3-03 Adjustable 4 Shelf Unit (52" x 60" x 13½")	1
6	9605-3-01 Accessory Back Panel (for 52" shelf unit 14½" tall)	2
7	9859-7-01 REDZONE Medium 6 Bin Set (13")	1
8	9892-7-01 REDZONE 2 Hook Holder (5" diameter)	1
9	9391-3-03 Heavy Duty Shelf Unit (for Secure Storage Modules - 42" x 60" x 16")	1
10	9045-3-02 5 Drawer Secure Storage Module (42" x 17" x 16")	1
11	9604-3-01 Accessory Back Panel (for 42" shelf unit 14½" tall)	1
12	9893-7-01 REDZONE 3 Hook Cord or Tool Holder	1
*13	975202-3-01 Van Shelf Mounting Kit - ProMaster 136" WB	1

\* Not Shown

## CABLE / PLUMBING

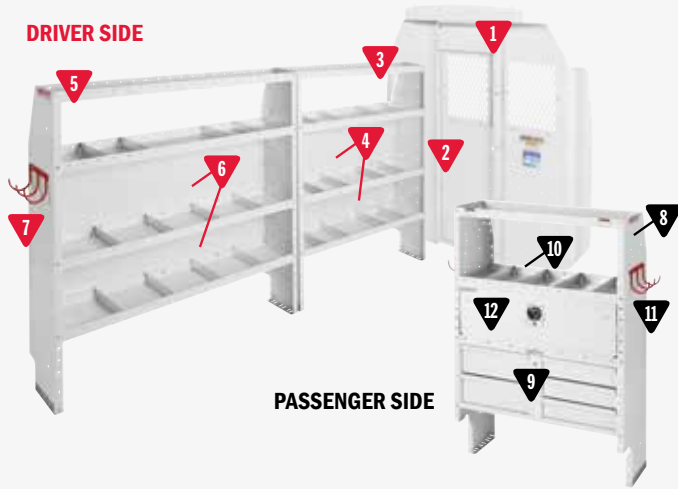

### 600-8442R Cable/Plumber Package

MODEL	DESCRIPTION	QUANTITY
1	96142-3-01 Screen Bulkhead - ProMaster®	1
2	96901-3-01 Swing Door Conversion Kit	1
3	9374-3-03 Adjustable 4 Shelf Unit (42" x 60" x 13½")	1
4	9604-3-01 Accessory Back Panel (for 42" Shelf Unit 14½" tall)	2
5	9375-3-03 Adjustable 4 Shelf Unit (52" x 60" x 13½")	1
6	9605-3-01 Accessory Back Panel (for 52" Shelf Unit 14½" tall)	2
7	9893-7-01 REDZONE 3 Hook Cord or Tool Holder	1
8	9391-3-03 Heavy Duty Shelf Unit (for Secure Storage Modules - 42" x 60" x 16")	1
9	9045-3-02 5 Drawer Secure Storage Module (42" x 17" x 16")	1
10	9604-3-01 Accessory Back Panel (for 42" Shelf Unit 14½" tall)	1
11	9893-7-01 REDZONE 3 Hook Cord or Tool Holder	1
12	9504-3-01 Shelf Door (for 42" Shelf Unit)	1
*13	975202-3-01 Van Shelf Mounting Kit - ProMaster 136" WB	1

\* Not Shown

## HVAC / MECHANICAL



### 600-8443R HVAC/Mechanical Package

MODEL	DESCRIPTION	QUANTITY
1	96142-3-01 Screen Bulkhead - ProMaster®	1
2	96901-3-01 Swing Door Conversion Kit	1
3	9374-3-03 Adjustable 4 Shelf Unit (42" x 60" x 13½")	1
4	9504-3-01 Shelf Door (for 42" Shelf Unit)	1
5	9604-3-01 Accessory Back Panel (for 42" Shelf Unit 14½" tall)	2
6	9375-3-03 Adjustable 4 Shelf Unit (52" x 60" x 13½")	2
7	9605-3-01 Accessory Back Panel (for 52" Shelf Unit 14½" tall)	2
8	9859-7-01 REDZONE Medium 6 Bin Set (13")	1
9	9880-3-01 Literature Holder 6 Compartment	1
10	9863-3-01 Refrigerant Tank Rack (2x 30#, 1x 50#)	1
11	9391-3-03 Heavy Duty Shelf Unit (for Secure Storage Modules - 42" x 60" x 16")	1
12	9045-3-02 5 Drawer Secure Storage Module (42" x 17" x 16")	1
13	9893-7-01 REDZONE 3 Hook Cord or Tool Holder	1
*14	975202-3-01 Van Shelf Mounting Kit - ProMaster 136" WB	1

\* Not Shown

## ELECTRICAL



### 600-8444R Electrical Package

MODEL	DESCRIPTION	QUANTITY
1	96142-3-01 Screen Bulkhead - ProMaster®	1
2	96901-3-01 Swing Door Conversion Kit	1
3	9374-3-03 Adjustable 4 Shelf Unit (42" x 60" x 13½")	1
4	9504-3-01 Shelf Door (for 42" Shelf Unit)	1
5	9604-3-01 Accessory Back Panel (for 42" Shelf Unit 14½" tall)	2
6	9859-7-01 REDZONE Medium 6 Bin Set (13")	1
7	9375-3-03 Adjustable 4 Shelf Unit (52" x 60" x 13 ½")	1
8	9605-3-01 Accessory Back Panel (for 52" Shelf Unit 14½" tall)	2
9	9858-7-01 REDZONE Small 6 Bin Set (13")	1
10	9882-7-01 REDZONE Wire Spool Holder End Mount	1
11	9391-3-03 Heavy Duty Shelf Unit (for Secure Storage Modules - 42" x 60" x 16")	1
12	9045-3-02 5 Drawer Secure Storage Module (42" x 17" x 16")	1
13	9504-3-01 Shelf Door (for 42" Shelf Unit)	1
14	9604-3-01 Accessory Back Panel (for 42" Shelf Unit 14½" tall)	2
15	9880-3-01 Literature Holder 6 Compartment	1
16	9893-7-01 REDZONE 3 Hook Cord or Tool Holder	1
*17	975202-3-01 Van Shelf Mounting Kit - ProMaster 136" WB	1

\* Not Shown

# HIGH ROOF PACKAGES 159" WB

From contractors to plumbers and electricians, we know that hard working professionals need flexibility to fit a new van to the job. These packages are customizable for your needs now or in the future with shelving and accessories starting on page 15.



**NEW!**

## ProMaster High Roof Mounting Kit

- Heavy gauge steel mounting plates distribute shelf load and provide secure mounting to van interior
- Mounts directly to reinforced weld nuts and cargo tie-downs or into existing holes (no drilling)
- Faster installation with reduced risk of damage to van during installation

MODEL	DESCRIPTION	WEIGHT
975203-3-01	Promaster 159" WB HR Mounting Kit	19 lbs.

## COMMERCIAL / BASE

DRIVER SIDE

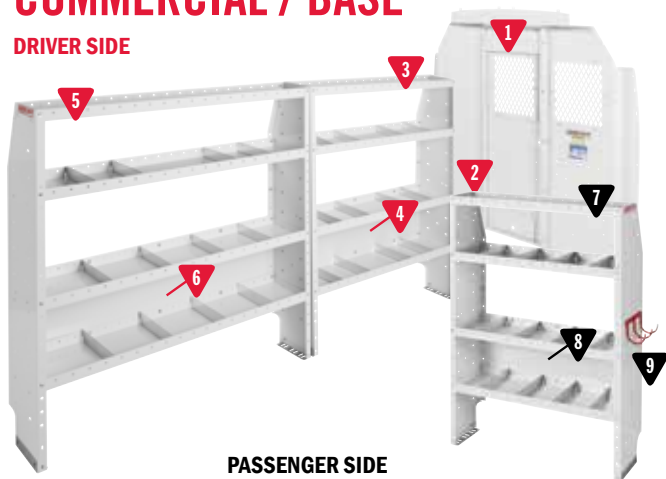

PASSENGER SIDE

## 600-8440L Commercial Shelving Package

MODEL	DESCRIPTION	QUANTITY
1	96142-3-01 Screen Bulkhead - ProMaster®	1
2	96901-3-01 Swing Door Conversion Kit	1
3	9375-3-03 Adjustable 4 Shelf Unit (52" x 60" x 13½")	1
4	9605-3-01 Accessory Back Panel (for 52" Shelf Unit 14½" tall)	1
5	9376-3-03 Adjustable 4 Shelf Unit (60" x 60" x 13½")	1
6	9606-3-01 Accessory Back Panel (for 60" Shelf Unit 14½" tall)	1
7	9375-3-03 Adjustable 4 Shelf Unit (52" x 60" x 13½")	1
8	9605-3-01 Accessory Back Panel (for 52" Shelf Unit 14½" tall)	1
9	9893-7-01 REDZONE 3 Hook Cord or Tool Holder	1
*10	975203-3-01 Van Shelf Mounting Kit - ProMaster 159" WB	1

\* Not Shown

## GENERAL SERVICE / CONTRACTOR

DRIVER SIDE

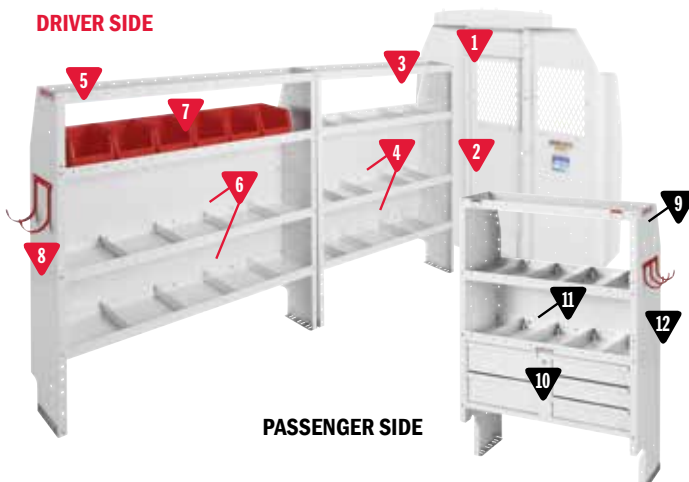

PASSENGER SIDE

## 600-8441L General Service/Contractor Package

MODEL	DESCRIPTION	QUANTITY
1	96142-3-01 Screen Bulkhead - ProMaster®	1
2	96901-3-01 Swing Door Conversion Kit	1
3	9375-3-03 Adjustable 4 Shelf Unit (52" x 60" x 13½")	1
4	9605-3-01 Accessory Back Panel (for 52" Shelf Unit 14½" tall)	2
5	9376-3-03 Adjustable 4 Shelf Unit (60" x 60" x 13½")	1
6	9606-3-01 Accessory Back Panel (for 60" Shelf Unit 14½" tall)	2
7	9859-7-01 REDZONE Medium 6 Bin Set (13")	1
8	9892-7-01 REDZONE 2 Hook Holder (5" diameter)	1
9	9391-3-03 Heavy Duty Shelf Unit (for Secure Storage Modules - 42" x 60" x 16")	1
10	9045-3-02 5 Drawer Secure Storage Module (42" x 17" x 16")	1
11	9604-3-01 Accessory Back Panel (for 42" Shelf Unit 14½" tall)	1
12	9893-7-01 REDZONE 3 Hook Cord or Tool Holder	1
*13	975203-3-01 Van Shelf Mounting Kit - ProMaster 159" WB	1

\* Not Shown



## CABLE / PLUMBING

DRIVER SIDE

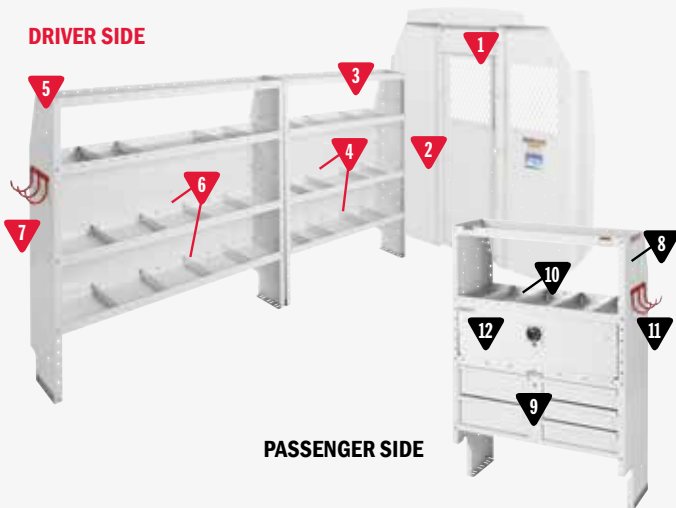

PASSENGER SIDE

### 600-8442L Cable/Plumber Package

MODEL	DESCRIPTION	QUANTITY
1	96142-3-01 Screen Bulkhead - ProMaster®	1
2	96901-3-01 Swing Door Conversion Kit	1
3	9375-3-03 Adjustable 4 Shelf Unit (52" x 60" x 13½")	1
4	9605-3-01 Accessory Back Panel (for 52" Shelf Unit 14½" tall)	2
5	9376-3-03 Adjustable 4 Shelf Unit (60" x 60" x 13½")	1
6	9606-3-01 Accessory Back Panel (for 60" Shelf Unit 14½" tall)	2
7	9893-7-01 REDZONE 3 Hook Cord or Tool Holder	1
8	9391-3-03 Heavy Duty Shelf Unit (for Secure Storage Modules - 42" x 60" x 16")	1
9	9045-3-02 5 Drawer Secure Storage Module (42" x 17" x 16")	1
10	9604-3-01 Accessory Back Panel (for 42" Shelf Unit 14½" tall)	1
11	9893-7-01 REDZONE 3 Hook Cord or Tool Holder	1
12	9504-3-01 Shelf Door (for 42" Shelf Unit)	1
*13	975203-3-01 Van Shelf Mounting Kit - ProMaster 159" WB	1

\* Not Shown

## HVAC / MECHANICAL

DRIVER SIDE

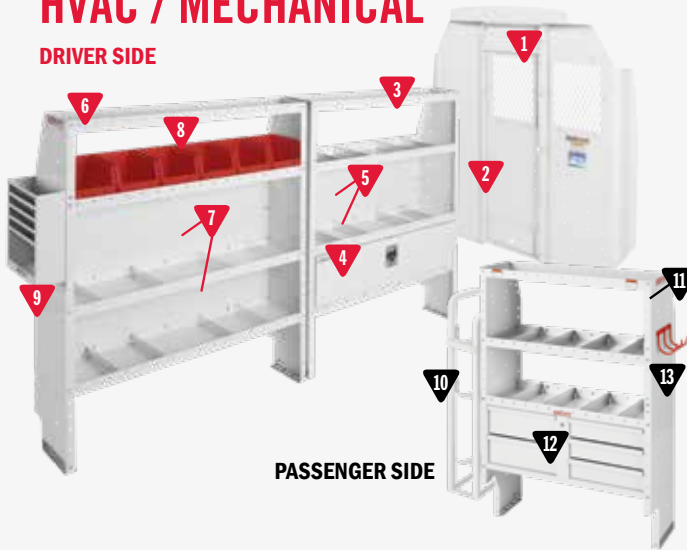

PASSENGER SIDE

### 600-8443L HVAC/Mechanical Package

MODEL	DESCRIPTION	QUANTITY
1	96142-3-01 Screen Bulkhead - ProMaster®	1
2	96901-3-01 Swing Door Conversion Kit	1
3	9375-3-03 Adjustable 4 Shelf Unit (52" x 60" x 13½")	1
4	9505-3-01 Shelf Door (for 52" Shelf Unit)	1
5	9605-3-01 Accessory Back Panel (for 52" Shelf Unit 14½" tall)	2
6	9376-3-03 Adjustable 4 Shelf Unit (60" x 60" x 13½")	1
7	9606-3-01 Accessory Back Panel (for 60" Shelf Unit 14½" tall)	2
8	9859-7-01 REDZONE Medium 6 Bin Set (13")	1
9	9880-3-01 Literature Holder 6 Compartment	1
10	9863-3-01 Refrigerant Tank Rack (2x 30#, 1x 50#)	1
11	9391-3-03 Heavy Duty Shelf Unit (for Secure Storage Modules - 42" x 60" x 16")	1
12	9045-3-02 5 Drawer Secure Storage Module (42" x 17" x 16")	1
13	9893-7-01 REDZONE 3 Hook Cord or Tool Holder	1
*14	975203-3-01 Van Shelf Mounting Kit - ProMaster 159" WB	1

\* Not Shown

## ELECTRICAL

DRIVER SIDE

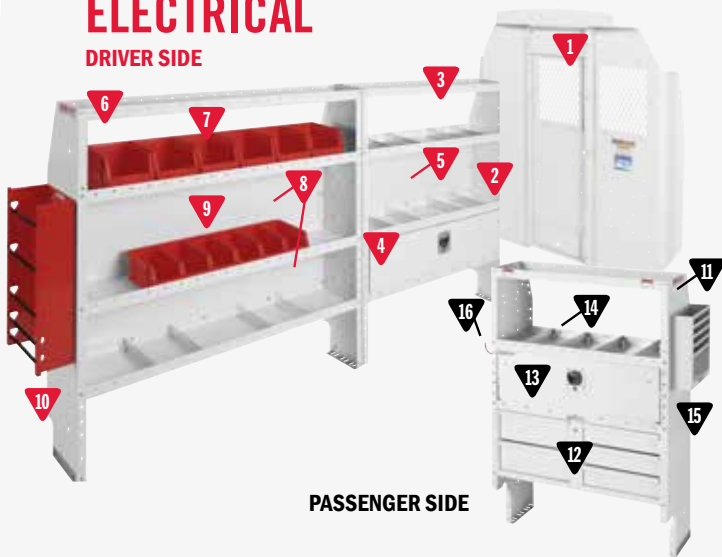

PASSENGER SIDE

### 600-8444L Electrical Package

MODEL	DESCRIPTION	QUANTITY
1	96142-3-01 Screen Bulkhead - ProMaster®	1
2	96901-3-01 Swing Door Conversion Kit	1
3	9375-3-03 Adjustable 4 Shelf Unit (52" x 60" x 13½")	1
4	9505-3-01 Shelf Door (for 52" Shelf Unit)	1
5	9605-3-01 Accessory Back Panel (for 52" Shelf Unit 14½" tall)	2
6	9376-3-03 Adjustable 4 Shelf Unit (60" x 60" x 13½")	1
7	9859-7-01 REDZONE Medium 6 Bin Set (13")	1
8	9606-3-01 Accessory Back Panel (for 60" Shelf Unit 14½" tall)	2
9	9858-7-01 REDZONE Small 6 Bin Set (13")	1
10	9882-7-01 REDZONE Wire Spool Holder End Mount	1
11	9391-3-03 Heavy Duty Shelf Unit (for Secure Storage Modules - 42" x 60" x 16")	1
12	9045-3-02 5 Drawer Secure Storage Module (42" x 17" x 16")	1
13	9504-3-01 Shelf Door (for 42" Shelf Unit)	1
14	9604-3-01 Accessory Back Panel (for 42" Shelf Unit 14½" tall)	1
15	9880-3-01 Literature Holder 6 Compartment	1
16	9893-7-01 REDZONE 3 Hook Cord or Tool Holder	1
*17	975203-3-01 Van Shelf Mounting Kit - ProMaster 159" WB	1

\* Not Shown

# HIGH ROOF PACKAGES 159" WB - EXTENDED LENGTH

Our Pro Packages help you organize your equipment and supplies, large and small. From recipis, drills and hand tools to expensive test equipment, the packages are customizable to meet your specific storage needs with a wide range of accessories starting on page 17.



**NEW!**

## ProMaster High Roof Mounting Kit

- Heavy gauge steel mounting plates distribute shelf load and provide secure mounting to van interior
- Mounts directly to reinforced weld nuts and cargo tie-downs or into existing holes (no drilling)
- Faster installation with reduced risk of damage to van during installation

MODEL	DESCRIPTION	WEIGHT
975204-3-01	Promaster 159" Extended WB HR Mounting Kit	27 lbs.

## COMMERCIAL / BASE

DRIVER SIDE

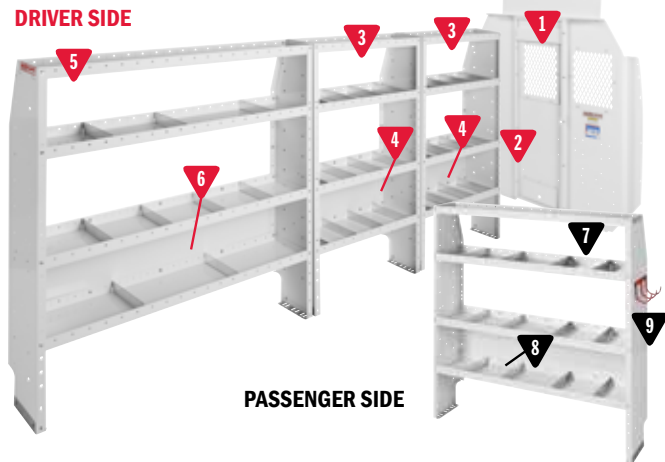

PASSENGER SIDE

## 600-8440X Commercial Shelving Package

MODEL	DESCRIPTION	QUANTITY
1	96142-3-01 Screen Bulkhead - ProMaster®	1
2	96901-3-01 Swing Door Conversion Kit	1
3	9373-3-03 Adjustable 4 Shelf Unit (36" x 60" x 13½")	2
4	9603-3-01 Accessory Back Panel (for 36" Shelf Unit 14½" tall)	2
5	9376-3-03 Adjustable 4 Shelf Unit (60" x 60" x 13½")	1
6	9606-3-01 Accessory Back Panel (for 60" Shelf Unit 14½" tall)	1
7	9376-3-03 Adjustable 4 Shelf Unit (60" x 60" x 13½")	1
8	9606-3-01 Accessory Back Panel (for 60" Shelf Unit 14½" tall)	1
9	9893-7-01 REDZONE 3 Hook Cord or Tool Holder	1
*10	975204-3-01 Van Shelf Mounting Kit - ProMaster 159" EXT WB	1

\* Not Shown

## GENERAL SERVICE / CONTRACTOR

DRIVER SIDE

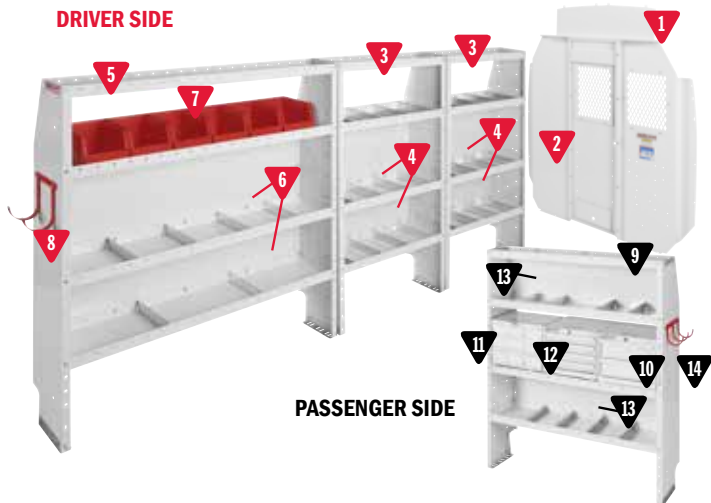

PASSENGER SIDE

## 600-8441X General Service/Contractor Package

MODEL	DESCRIPTION	QUANTITY
1	96142-3-01 Screen Bulkhead - ProMaster®	1
2	96901-3-01 Swing Door Conversion Kit	1
3	9373-3-03 Adjustable 4 Shelf Unit (36" x 60" x 13½")	2
4	9603-3-01 Accessory Back Panel (for 36" Shelf Unit 14½" tall)	4
5	9376-3-03 Adjustable 4 Shelf Unit (60" x 60" x 13½")	1
6	9606-3-01 Accessory Back Panel (for 60" Shelf Unit 14½" tall)	2
7	9859-7-01 REDZONE Medium 6 Bin Set (13")	1
8	9892-7-01 REDZONE 2 Hook Holder (5" diameter)	1
9	9375-3-03 Adjustable 4 Shelf Unit (52" x 60" x 13½")	1
10	9912-3-02 2 Drawer Cabinet (16" x 14" x 12")	1
11	9909-3-02 Parts Cabinet 9 Bin (16" x 12" x 12")	1
12	9914-3-02 4 Drawer Cabinet (16" x 14" x 12")	1
13	9605-3-01 Accessory Back Panel (for 52" Shelf Unit 14½" tall)	2
14	9893-7-01 REDZONE 3 Hook Cord or Tool Holder	1
*15	975204-3-01 Van Shelf Mounting Kit - ProMaster 159" EXT WB	1

\* Not Shown

## CABLE / PLUMBING

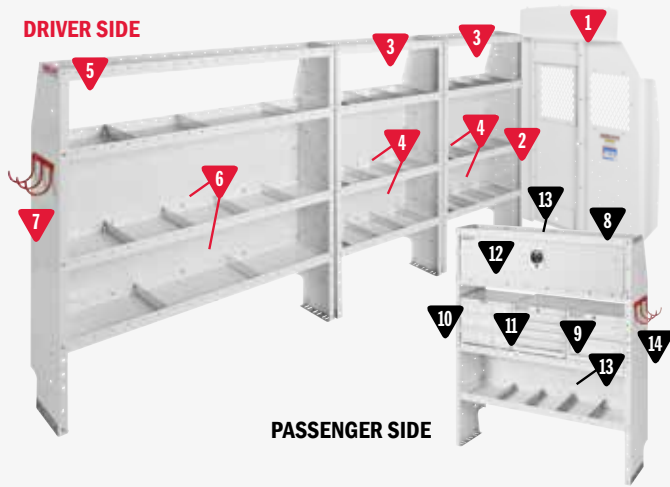

### 600-8442X Cable/Plumber Package

MODEL	DESCRIPTION	QUANTITY
1	96142-3-01 Screen Bulkhead - ProMaster®	1
2	96901-3-01 Swing Door Conversion Kit	1
3	9373-3-03 Adjustable 4 Shelf Unit (36" x 60" x 13½")	2
4	9603-3-01 Accessory Back Panel (for 36" Shelf Unit 14½" tall)	4
5	9376-3-03 Adjustable 4 Shelf Unit (60" x 60" x 13½")	1
6	9606-3-01 Accessory Back Panel (for 60" Shelf Unit 14½" tall)	2
7	9893-7-01 REDZONE 3 Hook Cord or Tool Holder	1
8	9375-3-03 Adjustable 4 Shelf Unit (52" x 60" x 13½")	1
9	9912-3-02 2 Drawer Cabinet (16" x 14" x 12")	1
10	9909-3-02 Parts Cabinet 9 Bin (16" x 12" x 12")	1
11	9914-3-02 4 Drawer Cabinet (16" x 14" x 12")	1
12	9505-3-01 Shelf Door (for 52" Shelf Unit)	1
13	9605-3-01 Accessory Back Panel (for 52" Shelf Unit 14½" tall)	2
14	9893-7-01 REDZONE 3 Hook Cord or Tool Holder	1
*15	975204-3-01 Van Shelf Mounting Kit - ProMaster 159" EXT WB	1

\* Not Shown

## HVAC / MECHANICAL

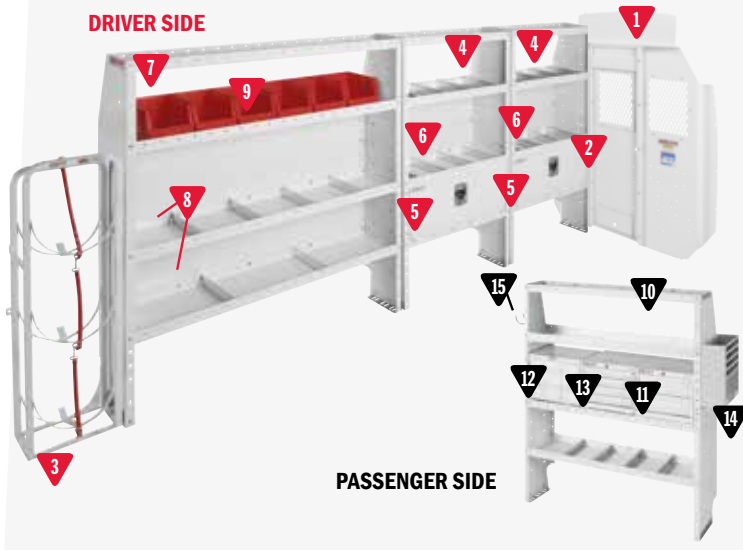

### 600-8443X HVAC/Mechanical Package

MODEL	DESCRIPTION	QUANTITY
1	96142-3-01 Screen Bulkhead - ProMaster®	1
2	96901-3-01 Swing Door Conversion Kit	1
3	9863-3-01 Refrigerant Tank Rack (2x 30#, 1x 50#)	1
4	9373-3-03 Adjustable 4 Shelf Unit (36" x 60" x 13½")	2
5	9503-3-01 Shelf Door (for 36" Shelf Unit)	2
6	9603-3-01 Accessory Back Panel (for 36" Shelf Unit 14½" tall)	4
7	9376-3-03 Adjustable 4 Shelf Unit (60" x 60" x 13½")	1
8	9606-3-01 Accessory Back Panel (for 60" Shelf Unit 14½" tall)	2
9	9859-7-01 REDZONE Medium 6 Bin Set (13")	1
10	9375-3-03 Adjustable 4 Shelf Unit (52" x 60" x 13½")	1
11	9912-3-02 2 Drawer Cabinet (16" x 14" x 12")	1
12	9909-3-02 Parts Cabinet 9 Bin (16" x 12" x 12")	1
13	9914-3-02 4 Drawer Cabinet (16" x 14" x 12")	1
14	9880-3-01 Literature Holder 6 Compartment	1
15	9893-7-01 REDZONE 3 Hook Cord or Tool Holder	1
*16	975204-3-01 Van Shelf Mounting Kit - ProMaster 159" EXT WB	1

\* Not Shown

## ELECTRICAL

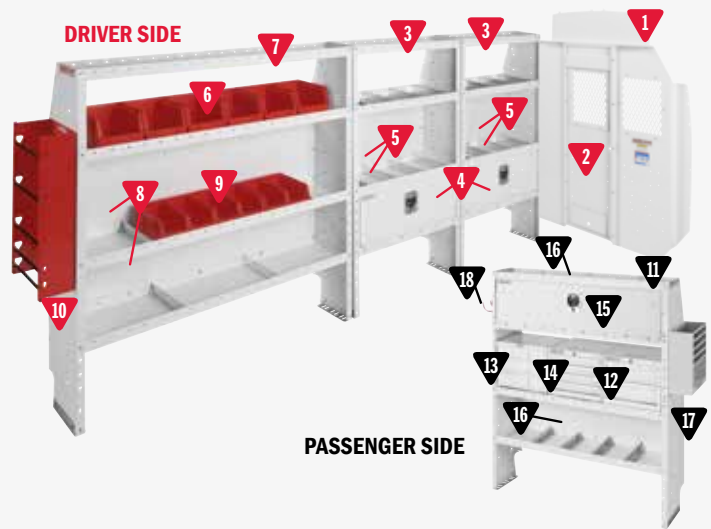

### 600-8444X Electrical Package

MODEL	DESCRIPTION	QUANTITY
1	96142-3-01 Screen Bulkhead - ProMaster®	1
2	96901-3-01 Swing Door Conversion Kit	1
3	9373-3-03 Adjustable 4 Shelf Unit (36" x 60" x 13½")	2
4	9503-3-01 Shelf Door for 36" Shelf Unit	2
5	9603-3-01 Accessory Back Panel (for 36" Shelf Unit 14½" tall)	4
6	9859-7-01 REDZONE Medium 6 Bin Set 13"	1
7	9376-3-03 Adjustable 4 Shelf Unit (60" x 60" x 13½")	1
8	9606-3-01 Accessory Back Panel (for 60" Shelf Unit 14½" tall)	2
9	9858-7-01 REDZONE Small 6 Bin Set (13")	1
10	9882-7-01 REDZONE Wire Spool Holder End Mount	1
11	9375-3-03 Adjustable 4 Shelf Unit (52" x 13½" x 60")	1
12	9912-3-02 2 Drawer Cabinet (16" x 14" x 12")	1
13	9909-3-02 Parts Cabinet 9 Bin (16" x 12" x 12")	1
14	9914-3-02 4 Drawer Cabinet (16" x 14" x 12")	1
15	9505-3-01 Shelf Door (for 52" Shelf Unit)	1
16	9605-3-01 Accessory Back Panel (52" x 14½" high)	2
17	9880-3-01 Literature Holder 6 Compartment	1
18	9893-7-01 REDZONE 3 Hook Cord or Tool Holder	1
*19	975204-3-01 Van Shelf Mounting Kit - ProMaster 159" EXT WB	1

\* Not Shown

# PROMASTER CITY PACKAGES



Keep it simple with room for the busiest days or fully load it up with shelves, drawers and bins to keep everything organized. Your ProMaster City works just as hard any other van on the road. Customize for your needs with accessories starting on page 17.

## ProMaster City Mounting Kit

- Heavy gauge steel mounting plates distribute shelf load and provide secure mounting to van interior
- Mounts directly to reinforced weld nuts and cargo tie-downs or into existing holes (no drilling)
- Faster installation with reduced risk of damage to van during installation

MODEL	DESCRIPTION	WEIGHT
9752-3-01	Rear Shelf Mounting Kit	15 lbs.
975205-3-01	Driver Side Mounting Kit	15 lbs.
975206-3-01	Passenger Side Mounting Kit	19 lbs.

## COMMERCIAL / BASE

DRIVER SIDE

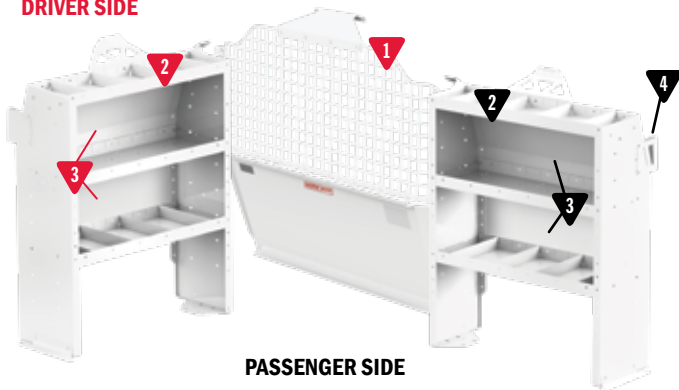

PASSENGER SIDE

## 600-8340 Commercial Shelving Package

MODEL	DESCRIPTION	QUANTITY
1	96112-3-01 Mesh Bulkhead - ProMaster City™	1
2/2	9353-3-03 Adjustable 3 Shelf Unit (36" x 44" x 13½")	2
3/3	9603-3-01 Accessory Back Panel (36" x 14½")	4
4	9752-3-01 Rear Shelving Mounting Kit - ProMaster City™	1

## GENERAL SERVICE

DRIVER SIDE

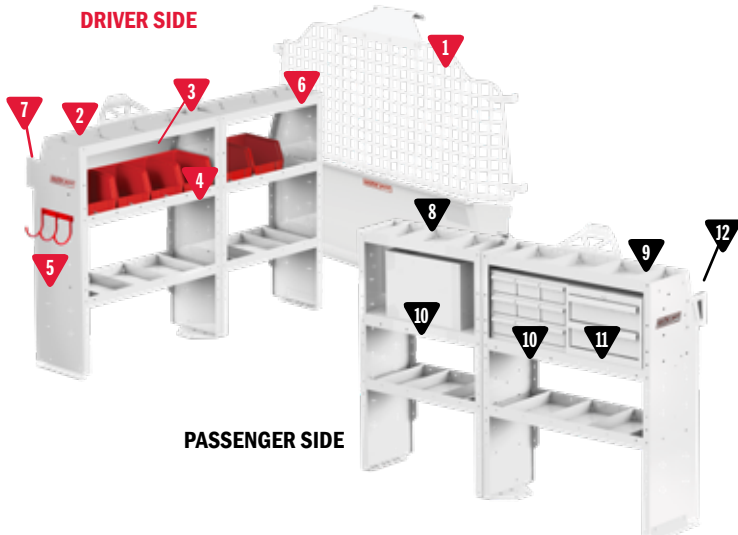

PASSENGER SIDE

## 600-8341 General Service Package

MODEL	DESCRIPTION	QUANTITY
1	96112-3-02 Mesh Bulkhead - ProMaster City™	1
2	9353-3-03 Adjustable 3 Shelf Unit (36" x 44" x 13½")	1
3	9603-3-01 Accessory Back Panel (36" x 14½")	1
4	9859-7-01 REDZONE Medium 6 Bin Set (13")	1
5	9893-7-01 REDZONE 3 Hook Cord or Tool Holder	1
6	9352-3-03 Adjustable 3 Shelf Unit (28" x 44" x 13½")	1
7	975205-3-01 Mounting Kit - ProMaster City™ Driver Side	1
8	9352-3-03 Adjustable 3 Shelf Unit (28" x 44" x 13½")	1
9	9353-3-03 Adjustable 3 Shelf Unit (36" x 44" x 13½")	1
10	9909-3-02 Parts Cabinet 9 Bin Set (16" x 14" x 12")	2
11	9912-3-02 2 Drawer Cabinet (16" x 14" x 12")	1
12	975206-3-01 Mounting Kit - ProMaster City™ Passenger Side	1

# PLUMBING

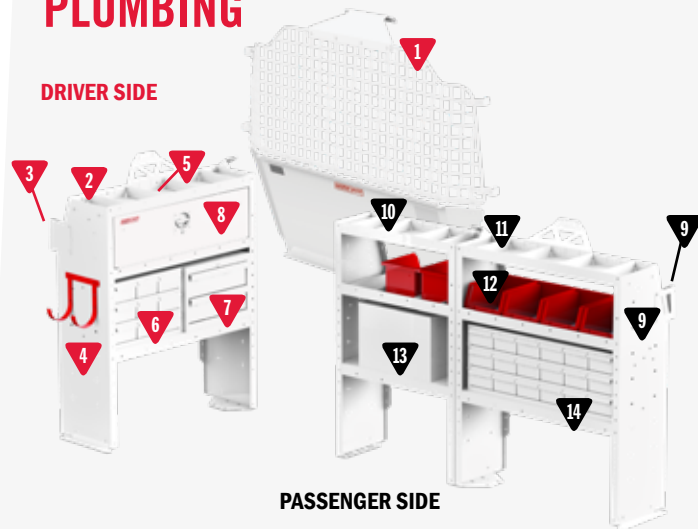

## 600-8342 Plumbing Package

MODEL	DESCRIPTION	QUANTITY
1	96112-3-02 Mesh Bulkhead - ProMaster City™	1
2	9353-3-03 Adjustable 3 Shelf Unit (36" x 36" x 13½")	1
3	975205-3-01 Driver Side Mounting Kit - ProMaster City™	1
4	9892-7-01 REDZONE 2 Hook Holder (5" diameter)	1
5	9603-3-01 Accessory Back Panel (for 36" Shelf Unit 14½" tall)	1
6	9909-3-02 Parts Cabinet 9 Bin (16" x 12" x 12")	1
7	9912-3-02 2 Drawer Cabinet (16" x 14" x 12")	1
8	9503-3-01 Shelf Door (for 36" Shelf Unit)	1
9	975206-3-01 Passenger Side Mounting Kit - ProMaster City™	1
10	9352-3-03 Adjustable 3 Shelf Unit (28" x 44" x 13½")	1
11	9353-3-03 Adjustable 3 Shelf Unit (36" x 44" x 13½")	1
12	9859-7-01 REDZONE Medium 6 Bin Set (13")	1
13	9909-3-02 Parts Cabinet 9 Bin (16" x 12" x 12")	1
14	9918-3-02 Parts Cabinet 18 Bin (32" x 12" x 12")	1

# HVAC / MECHANICAL

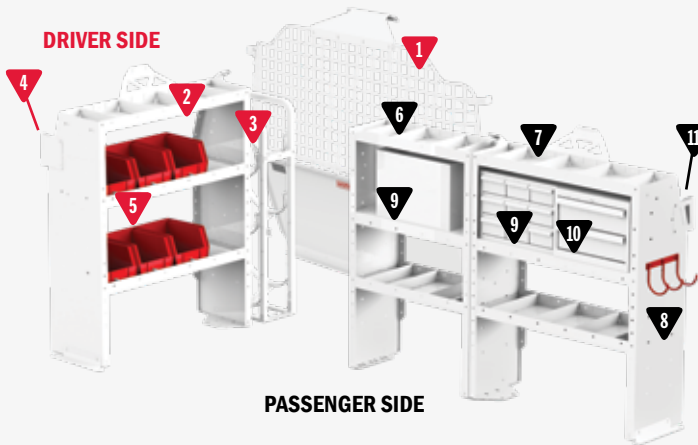

## 600-8343 HVAC/Mechanical Package

MODEL	DESCRIPTION	QUANTITY
1	96111-3-02 Mesh Bulkhead - ProMaster City™	1
2	9353-3-03 Adjustable 3 Shelf Unit (36" x 36" x 13½")	1
3	9863-3-01 Refrigerant Tank Rack (1 x 50 lbs., 2 x 30lbs.)	1
4	975205-3-01 Driver Side Mounting Kit - ProMaster City™	1
5	9859-7-01 REDZONE Medium 6 Bin Set (7" x 8" x 12")	1
6	9352-3-03 Adjustable 3 Shelf Unit (28" x 44" x 13½")	1
7	9353-3-03 Adjustable 3 Shelf Unit (36" x 44" x 13½")	1
8	9893-7-01 REDZONE 3 Hook Cord or Tool Holder	1
9	9909-3-02 Parts Cabinet 9 Bin (16" x 12" x 12")	2
10	9912-3-02 2 Drawer Cabinet (16" x 14" x 12")	1
11	975206-3-01 Passenger Side Mounting Kit - ProMaster City™	1

# ELECTRICAL

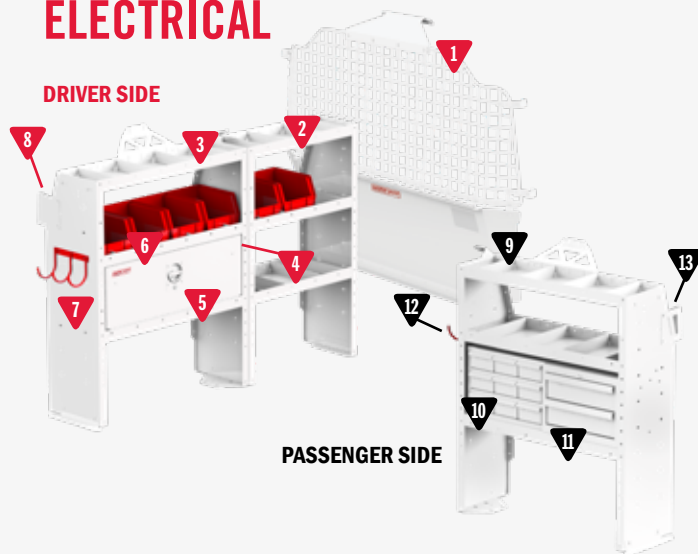

## 600-8344 Electrical Package

MODEL	DESCRIPTION	QUANTITY
1	96112-3-02 Mesh Bulkhead - ProMaster City™	1
2	9352-3-03 Adjustable 3 Shelf Unit (28" x 44" x 13½")	1
3	9353-3-03 Adjustable 3 Shelf Unit (36" x 44" x 13½")	1
4	9603-3-01 Accessory Back Panel (for 36" Shelf Unit 14½" tall)	1
5	9503-3-01 Shelf Door (for 36" Shelf Unit)	1
6	9859-7-01 REDZONE Medium 6 Bin Set 13"	1
7	9893-7-01 REDZONE 3 Hook Cord or Tool Holder	1
8	975205-3-01 Driver Side Mounting Kit - ProMaster City™	1
9	9353-3-03 Adjustable 3 Shelf Unit (36" x 44" x 13½")	1
10	9909-3-02 Parts Cabinet 9 Bin (16" x 12" x 12")	1
11	9912-3-02 2 Drawer Cabinet (16" x 14" x 12")	1
12	9893-7-01 REDZONE 3 Hook Cord or Tool Holder	1
13	975206-3-01 Passenger Side Mounting Kit - ProMaster City™	1

# BULKHEADS

WEATHER GUARD® Van Bulkheads separate the driver compartment from the cargo area for maximum protection against shifting loads. Polycarbonate windows reduce noise and provide visibility through the bulkhead. The angled design cuts glare to improve visibility and safety. Bulkhead accessories are available to make the most of organization space in your van. Deep offset bulkheads provide superior comfort in the cab area allowing full seat travel.

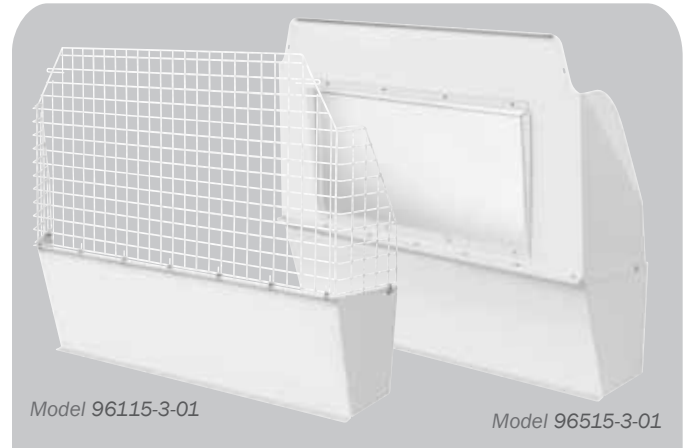

## Bulkhead for Ram ProMaster®

Improved visibility, safety, and security for occupants and cargo protection. Exclusive design fits both Standard and High Roof Ram ProMaster®.

MODEL	DESCRIPTION	WEIGHT
96141-3-01	Polycarbonate Window Bulkhead	105 lbs.
96142-3-01	Steel Mesh Screen Bulkhead	105 lbs.
96901-3-01	Hinge Kit converts bulkhead to swinging door with lockable latch	4 lbs.
96903-3-01	Solid Bulkhead Panel Adapter Kit	10 lbs.

## Bulkhead for C/V Tradesman®

Options provide protection, prevent unauthorized access, and offer excellent visibility of the cargo area from the passenger compartment.

MODEL	DESCRIPTION	WEIGHT
96115-3-01	Lightweight Mesh Bulkhead	35 lbs.
96515-3-01	Window Bulkhead (maximizes front seat comfort)	40 lbs.



## Bulkhead for Ram ProMaster City™

Window bulkheads offer unobstructed visibility of the cargo area, side door, and rear door. Maximizes comfort in the passenger area. Lightweight mesh bulkheads deliver full driver and cargo protection.

MODEL	DESCRIPTION	WEIGHT
96112-3-01	Mesh Bulkhead, Ram ProMaster City™	35 lbs.
96512-3-01	Window Bulkhead, Ram ProMaster City™	40 lbs.

## Bulkhead Accessories

Improve organization and productivity with easy to install accessories.

MODEL	DESCRIPTION	WEIGHT
1 8875	Hard Hat Bracket	2 lbs.
2 8866	Fire Extinguisher	6 lbs.
3 9879-7-01	Tool Organizer	4 lbs.
4 96901-3-01	Optional Hinge Kit	4 lbs.
5 96903-3-01	Solid Steel Panel Conversion Kit	10 lbs.

# ADJUSTABLE SHELVING

## 17° TAPERED END PANEL CLOSER FIT

for more working space inside the van

## DEEP FULLY HEMMED SHELVES

sized for tools, equipment, and other materials

## EASY TO CUSTOMIZE

with pre-punched mounting holes for WEATHER GUARD® accessories and cabinets

## EASY TO ASSEMBLE AND "STALL"

with captive nuts on each shelf and complete "stallation" hardware



## ADJUSTABLE DIVIDERS

Includes pack of four adjustable dividers for each shelf

## PUNCHED SHELVES

for easier "stallation" of accessory cabinets

## FRONT FLOOR CLEARANCE (16" SHELVES ONLY)

for material storage. Fits PACK RAT® Drawer Units

## UNMATCHED DURABILITY

achieved with heavy duty 18 gauge steel construction

## FLAT FRONTS

on 13-1/2" deep adjustable shelves. Mount doors and accessories at floor level

**WEATHER GUARD® EXCLUSIVE!**



## Shelf Units: Ships complete in one carton

MODEL	HEIGHT	WIDTH	DEPTH	SHELVES	DIVIDERS	WEIGHT
9333-3-03	34"	36"	13½"	2	8	48 lbs.
9334-3-03	34"	42"	13½"	2	8	48 lbs.
9335-3-03	34"	52"	13½"	2	8	72 lbs.
9336-3-03	34"	60"	13½"	2	8	70 lbs.
9343-3-03	44"	36"	16"	3	12	74 lbs.
9344-3-03	44"	42"	16"	3	12	80 lbs.
9345-3-03	44"	52"	16"	3	12	85 lbs.
9346-3-03	44"	60"	16"	3	12	104 lbs.
<b>NEW!</b> 9352-3-03	44"	28"	13½"	3	12	50 lbs.
9353-3-03	44"	36"	13½"	3	12	53 lbs.
9354-3-03	44"	42"	13½"	3	12	57 lbs.
9355-3-03	44"	52"	13½"	3	12	66 lbs.
9356-3-03	44"	60"	13½"	3	12	73 lbs.
9363-3-03	60"	36"	16"	4	16	92 lbs.
9364-3-03	60"	42"	16"	4	16	94 lbs.
9365-3-03	60"	52"	16"	4	16	110 lbs.
9366-3-03	60"	60"	16"	4	16	136 lbs.
9373-3-03	60"	36"	13½"	4	16	76 lbs.
9374-3-03	60"	42"	13½"	4	16	94 lbs.
9375-3-03	60"	52"	13½"	4	16	110 lbs.
9376-3-03	60"	60"	13½"	4	16	136 lbs.

## 24" Deep Jumbo Shelving Items

Extra deep 24" shelving constructed of 18-gauge steel and finished with durable brite white powder coat. These shelves are easy to assemble and provide the perfect foundation for a customized van or trailer. Special order only, with longer lead times.



MODEL	HEIGHT	WIDTH	DEPTH	SHELVES
8393-3-01	59½"	42¼"	24"	3
8394-3-01	59½"	51¼"	24"	3
8395-3-01	59½"	69¼"	24"	3
8118-3-01	Short Bin Dividers for 24"D Shelves			

**NEW ITEMS AVAILABLE JUNE 2018**

**weather guard**

# SECURE STORAGE

Add extra security and theft-resistance for valuable tools and equipment with WEATHER GUARD® Secure Storage shelf units. Multiple door and drawer modules easily assemble into shelving. Our welded steel construction and heavy-duty locking mechanism ensures peace of mind on the job or in the parking lot.

- ! HIGH SECURITY**  
welded steel box and shelf construction
- ! UNMATCHED ORGANIZATION & EFFICIENCY**  
with no wasted space below or between drawers
- ! UNMATCHED DURABILITY**  
box construction strengthens and rigidizes shelf unit
- ! EXTRA LARGE STEEL DRAWERS**  
17"x14"x4" or 6" with ball bearing slides rated at 75 pounds per drawer
- ! FAST AND EASY ASSEMBLY**  
modules bolt to end panels. Add top shelf to complete unit.
- ! FULLY FUNCTIONAL 16" SECURE MODULE TOP**  
designed like a 16" shelf for additional storage



**WEATHER GUARD® EXCLUSIVE!** **!**

Select the shelf unit to fit your van, then the storage module to fit your needs.

## Secure Storage Shelf Units (42" Wide)

MODEL		HEIGHT	DIVIDERS	WEIGHT
9381-3-03	Full Size Vans	44"	8	104 lbs.
Includes end panel and top shelf for secure storage unit				
9391-3-03	High Roof Vans	60"	12	108 lbs.
Includes end panels, top and center shelf for secure storage unit				
9040-3-01	Door Module			47 lbs.
9045-3-02	5 Drawer Module			78 lbs.

## Secure Storage Service Parts

MODEL	DESCRIPTION	WEIGHT
70206-xx	Replacement Lock Kit	117 lbs.
70210-xx	Key Kit	1 lb.
70211-xx	Replacement D Handle Kit	1 lb.

xx- Designates key code  
Specify key code 11-20 when ordering



Door Module  
9040-3-01



5 Drawer  
Module  
9045-3-02



# ACCESSORIES



## Shelf Doors with High Security D Handle Lock

Mount to shelf units or to retainer lips. Single point D-handle lock for added security. Allow seven mounting holes shelf to shelf spacing

MODEL	HEIGHT	SHELF WIDTH	WEIGHT
<b>NEW!</b> 9502-3-01	11"	28"	10 lbs.
9503-3-01	11"	36"	13 lbs.
9504-3-01	11"	42"	17 lbs.
9505-3-01	11"	52"	21 lbs.
9506-3-01	11"	60"	25 lbs.

## Light Weight Shelf Back Panels

Use with shelf doors to turn a shelf into a cabinet

MODEL	HEIGHT	SHELF WIDTH	WEIGHT
<b>NEW!</b> 9602-3-02	7¾"	28"	2 lbs.
9603-3-02	7¾"	36"	2 lbs.
9604-3-02	7¾"	42"	3 lbs.
9605-3-02	7¾"	52"	4 lbs.
9606-3-02	7¾"	60"	5 lbs.
<b>NEW!</b> 9602-3-01	14½"	28"	4 lbs.
9603-3-01	14½"	36"	4 lbs.
9604-3-01	14½"	42"	6 lbs.
9605-3-01	14½"	52"	8 lbs.
9606-3-01	14½"	60"	10 lbs.

## Retainer Lips

Keeps items in place under shelf units

MODEL	HEIGHT	SHELF WIDTH	DEPTH	WEIGHT
<b>NEW!</b> 9702-3-02	1½"	28"	1½"	1 lb.
9703-3-02	1½"	36"	1½"	1 lb.
9704-3-02	1½"	42"	1½"	1 lb.
9705-3-02	1½"	52"	1½"	2 lbs.
9706-3-02	1½"	60"	1½"	2 lbs.

## End Panels

Can't find the shelf combination you need? Configure your own shelf system with end panels and accessory shelves.

MODEL	HEIGHT	WIDTH	DEPTH	WEIGHT
9243-3-01	36"	2"	13½"	22 lbs.
9244-3-01	44"	2"	13½"	18 lbs.
9246-3-01	60"	2"	13½"	33 lbs.
9274-3-01	44"	2"	16"	30 lbs.
9276-3-01	60"	2"	16"	34 lbs.

## Extra Shelves

Includes one set of dividers

MODEL	HEIGHT	WIDTH	DEPTH	WEIGHT
<b>NEW!</b> 9142-3-01	2"	28"	13½"	10 lbs.
9143-3-01	2"	36"	13½"	14 lbs.
9144-3-01	2"	42"	13½"	18 lbs.
9145-3-01	2"	52"	13½"	22 lbs.
9146-3-01	2"	60"	13½"	26 lbs.
9163-3-01	2"	36"	16"	14 lbs.
9164-3-01	2"	42"	16"	18 lbs.
9165-3-01	2"	52"	16"	22 lbs.
9166-3-01	2"	60"	16"	26 lbs.



## Locking Storage & CATV Cabinets

MODEL	SHELVES	HEIGHT	WIDTH	DEPTH	WEIGHT
<b>1</b> 9020-3-01	N/A	22"	18"	16"	25 lbs.
<b>2</b> 9021-3-01	2*	22"	18"	16"	35 lbs.

\*Removable Shelves



## Bin Sets

Sturdy plastic bins sized to fit 16" or 13" deep adjustable van shelving

MODEL	HEIGHT	WIDTH	DEPTH	BINS	WEIGHT
9854-7-01	5"	5½"	14¾"	9	8 lbs.
9855-7-01	7"	8¼"	14¾"	6	10 lbs.
9856-7-01	7"	16½"	14¾"	3	8 lbs.
9858-7-01	5"	5½"	10⅞"	6	8 lbs.
9859-7-01	7"	7"	10⅞"	6	8 lbs.



Model 89011

## Van Floor Mats

Designed to cover seating wells in the van floor. Required when installing bulkhead units and other equipment.

MODEL	VAN TYPE	WHEELBASE	WEIGHT
89011	70" x 124" rectangular (must be cut to fit any style vans)		55 lbs.
89020	'14 & Newer Ram ProMaster®	118"	32 lbs.
89021	'14 & Newer Ram ProMaster®	136"	39 lbs.
89022	'14 & Newer Ram ProMaster®	158"	46 lbs.
89023	'14 & Newer Ram ProMaster®	158" Extended	49 lbs.

**NEW ITEMS AVAILABLE JUNE 2018**



# ACCESSORIES

## GRAB & GO TOOL CART

Our new, modular 3-piece rolling tool chest puts those tools and parts used on every job at your fingertips. Heavy-duty construction keeps your productivity rolling for years to come.

- Modular, 3-piece rolling tool chest
- Removable tool box with steel tray
- Sliding drawer unit
- Tilt-out storage bin
- Telescoping handle



### Grab & Go Tool Cart

MODEL	HEIGHT	WIDTH	DEPTH	BOXES	WEIGHT
9953-7-01	28½"	20"	12"	3	24 lbs.



### Floor Mounted Accessories

MODEL	DESCRIPTION	HEIGHT	WIDTH	DEPTH	WEIGHT
1	9861-3-01 Cable Spool Holder	42½"	19¾"	16¾"	37 lbs.
2	9862-3-01 3-50 lb. Tank Holder	45½"	15½"	8"	31 lbs.
3	9863-3-01 2-30 lb., 1-50 lb. Tank Holder	40"	15½"	8"	27 lbs.
4	9864-3-01 4-30 lb. Tank Holder	48½"	13"	8"	31 lbs.
5	9860-3-01 Catalog File Unit	36"	6"	12"	16 lbs.
6	9885-7-01 5 Gal. Bucket Holder	6¼"	11¼"	11¼"	8 lbs.



### Door Trays and Literature Holders

MODEL	HEIGHT	WIDTH	DEPTH	WEIGHT	
1	9871-3-01	21¾"	20¼"	4⅝"	19 lbs.
2	9872-3-01	21¾"	20¼"	4⅝"	18 lbs.
3	9873-3-01	21¾"	20¼"	4⅝"	19 lbs.
4	9880-3-01	16"	13"	5"	11 lbs.

# REDZONE ACCESSORIES

Looking for parts and supplies won't slow you down with new and re-engineered REDZONE van storage accessories. Organizers and holders keep frequently used items in easy reach for maximum productivity. Tool cabinets, parts bin boxes, and locking storage keep small components organized.

**CUSTOMIZED ORGANIZATION**  
for supplies and tools

**HEAVY DUTY 18 GAUGE STEEL CONSTRUCTION**  
makes for tough, long lasting accessories

**POWDER COAT FINISH**  
provides durability

**EASY TO INSTALL**  
to shelf end panels, bulkheads, and door



## BUCKET AND TANK HOLDERS



## HOOKS AND BRACKETS

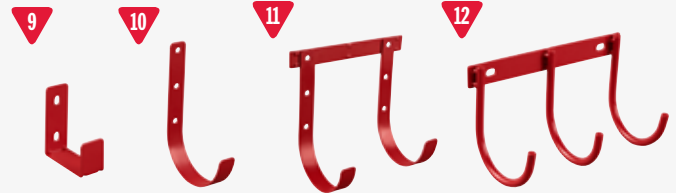

## REDZONE Accessories

	MODEL	DESCRIPTION	HEIGHT	WIDTH	DEPTH	WEIGHT
1	9874-7-01	Can Organizer	9.8"	12"	4"	3 lbs.
2	9879-7-01	Tool Organizer	5½"	15"	4"	3 lbs.
3	9881-7-01	Caulk Tube Tray	7½"	13½"	7½"	4¼ lbs.
4	9882-7-01	Wire Spool Holder End Mount	26"	14"	6"	12 lbs.
5	9883-7-01	Large Parts Bin	11"	13"	7"	10 lbs.
6	9884-7-01	Medium Parts Bin	6½"	13"	7"	8 lbs.
7	9885-7-01	5 Gallon Bucket Holder	6¼"	11¼"	11¼"	8 lbs.
8	9886-7-01	30# Refrigerant Tank Holder	10¾"	9¾"	9¾"	9 lbs.
9	9887-7-01	Ladder Holder	4"	1½"	3½"	¼ lb.
10	9891-7-01	Large Hook (5" diameter)	8"	1¼"	5"	½ lb.
11	9892-7-01	2 Hook Holder (5" diameter)	8"	9"	5"	½ lb.
12	9893-7-01	3 Hook Cord or Tool Holder	5¼"	9"	4½"	½ lb.

# CABINETS



## Mechanics Grade Tool Cabinets

High quality and durable mechanics-grade Tool Cabinets for your van feature easy-to-grip handles, smooth ball-bearing rollers, latches for each drawer, and secure locks that can be keyed alike. Bin Cabinets feature hook and loop fasteners to securely hold bins in place.

	MODEL	DRAWERS	HEIGHT	WIDTH	DEPTH	WEIGHT
1	9912-3-02	2	12"	16"	13.7"	26 lbs.
2	9914-3-02	4	12"	16"	13.7"	32 lbs.
3	9924-3-02	4	24"	16"	13.7"	48 lbs.
4	9928-3-02	8	24"	16"	13.7"	60 lbs.
5	9984-3-01	4	24"	18"	13.7"	53 lbs.
6	9988-3-01	8	24"	18"	13.7"	60 lbs.

## Cabinet Divider Kits

MODEL	DESCRIPTION	WEIGHT
9822-3-01	Divider and Liner Kit for 9914-3-02, 9928-3-02	2 lbs.
9824-3-01	Divider and Liner Kit for 9912-3-02, 9924-3-02	2 lbs.



## Parts Boxes & Bin Cabinets

	MODEL	BINS	HEIGHT	WIDTH	DEPTH	WEIGHT
1	9906-3-02	6	4½"	32½"	11¾"	18 lbs.
2	9909-3-02	9	12"	17"	11¾"	28 lbs.
3	9918-3-02	18	12"	32½"	11¾"	54 lbs.
4	9950-7-02*	N/A	12.6"	20.3"	14.4"	4 lbs.
5	9951-9-01	N/A	3"	18½"	13"	3 lbs.
Special Order Cabinets (Call for availability. Longer lead time required)						
6	8908-3	8	8½"	22 "	11¾"	24 lbs.

\*Parts cases not included



- 1 Invert shelf when assembling it and mount cabinet directly to shelf.
- 2 Keep shelf facing up and use Cabinet Mounting Spacer kit Model 9994. Order separately.

## Cabinet Accessory Mounting

The new van shelf design includes cabinet mounting holes that make it easier to assemble and install. There are two fast ways to mount cabinet and parts boxes to van shelves.

MODEL	DESCRIPTION	WEIGHT
9994	Shelf Cabinet Mounting Kit	1 lb.
9996-3-01	Shelf Accessory Mounting Kit (16")	1 lb.

# DRAWER UNITS

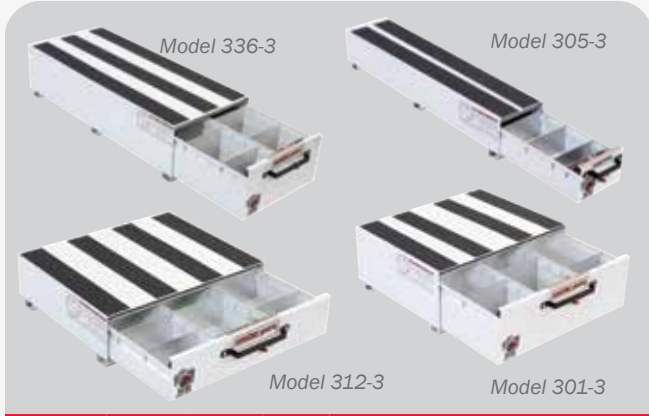

## PACK RAT® Drawer Units

MODEL	HEIGHT	WIDTH	DEPTH	COMPARTMENTS	DIVIDERS	WEIGHT
<b>STEEL DRAWER UNITS</b>						
301-3	12½"	30"	24"	3	12	169 lbs.
303-3	12½"	39¾"	24"	4	12	217 lbs.
304-3	9"	30"	48"	2	6	220 lbs.
305-3	9"	10¼"	48"	1	6	106 lbs.
306-3	9"	20"	48"	2	12	179 lbs.
307-3	9"	30"	48"	3	18	247 lbs.
308-3	9"	39¾"	48"	4	24	322 lbs.
308-5	9"	39¾"	48"	4	24	322 lbs.
312-3	9"	30"	24"	3	12	151 lbs.
334-3	12½"	30"	48"	2	6	245 lbs.
335-3	12½"	10¼"	48"	1	6	130 lbs.
336-3	12½"	20"	48"	2	12	210 lbs.
337-3	12½"	30"	48"	3	18	294 lbs.
338-3	12½"	39¾"	48"	4	24	383 lbs.
338-5	12½"	39¾"	48"	4	24	383 lbs.
<b>ALUMINUM DRAWER UNITS</b>						
310-3-01	14½"	11¾"	42"	1	0	56 lbs.



## ITEMIZER® Drawer Units

These storage solutions conveniently increase your storage space by placing small equipment at your fingertips without the need to crawl inside the van. Drawer dividers provide an extensive array of organizing options.

- Lightweight Aluminum Drawers carry up to 75 lbs. each
- Units Can be stacked as needed for additional storage
- Roller mounted drawers glide open to full extension
- Adjustable drawer dividers offer greater flexibility
- Anti-Skid Strips provide traction for wet and muddy boots

MODEL	DRAWERS	HEIGHT	WIDTH	DEPTH	WEIGHT
314-3	1	6¾"	12¼"	49"	26 lbs.
316-3	2 Lateral	6¾"	24"	49"	55 lbs.
317-3	3 Lateral	6¾"	36"	49"	85 lbs.
318-3	4 Lateral	6¾"	48"	49"	110 lbs.
326-3	2 Stacked	12¼"	12¼"	49"	48 lbs.
327-3	3 Stacked	17¾"	12¼"	49"	71 lbs.
328-3	4 Stacked	23½"	12¼"	49"	92 lbs.

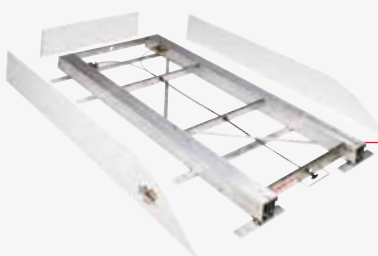

**FOR FULL-SIZE VAN & MINIVAN REAR DOOR**

Model 3200

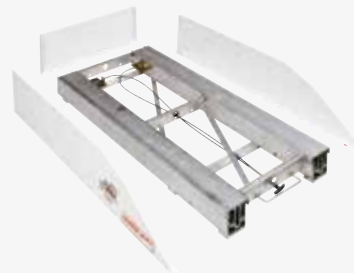

**FOR FULL-SIZE VAN SIDE DOOR**

Model 3100

**FOR LONG WHEEL BASE FULL-SIZE VAN REAR DOOR**

Model 3400

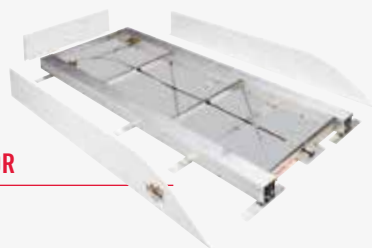

## BED RAT® Sliding Platforms

MODEL	HEIGHT	WIDTH	DEPTH	WEIGHT
3100	4¾"	22"-44¾"	54"	97 lbs.
3200	4¾"	44¾"	68"	123 lbs.
3400	4¾"	44¾"	90"	155 lbs.

# EZGlide2™ DROP-DOWN LADDER RACK



**EASIEST TO OPERATE**  
50% less effort to operate than competitor drop-down ladder racks, reducing strain on the operator

**LIGHTEST WEIGHT**  
Drop-down ladder rack available

- Maximize fuel economy
- Maximize carrying capacity

**MOST VERSATILE**

- Up to 40' extension ladders
- 3' - 10' stepladders
- Conduit carriers

## STEP 1 CHOOSE A MOUNTING KIT

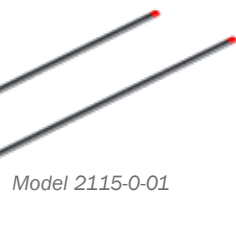

Model 2115-0-01

### Mounting Channel Kits

All Mounting Channel Kits attach to factory mounting points. No drilling required. All hardware included.

MODEL	DETAILS	WEIGHT
2115-0-01	Mounting Channel Kit - ProMaster®	15 lbs.
2085-0-01	Mounting Channel Kit - ProMaster City™	15 lbs.

## STEP 2 SELECT A DROP-DOWN LADDER RACK ASSEMBLY (Single-Side Only with Crossmembers)

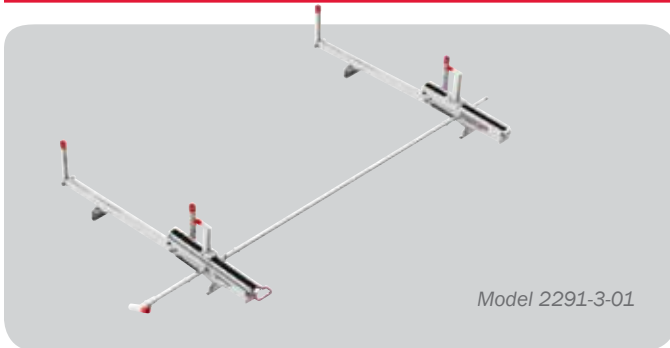

Model 2291-3-01

### Drop-Down Ladder Rack Assemblies

Drop-down can mount on driver or passenger side. Rack fits 16' to 40' Extension, 5' to 10' Step and 3' to 8' Podium, evenly distributed on ladder rack. Carry ladders appropriate to the size of the vehicle.

MODEL	DETAILS	WEIGHT
2291-3-01	Extended Drop-Down - Mid-Roof or High-Roof (Includes two 70" Cross Members which can be set at 96" or 77" center to center)	77 lbs.
2261-3-01	Fixed Drop-Down - Compact (Includes two 60" Cross Members which can be set at 77" center to center)	83 lbs.

Always properly secure ladders to the ladder rack while driving. Transporting ladders longer than the vehicle is not recommended.

## KITS AND ACCESSORIES

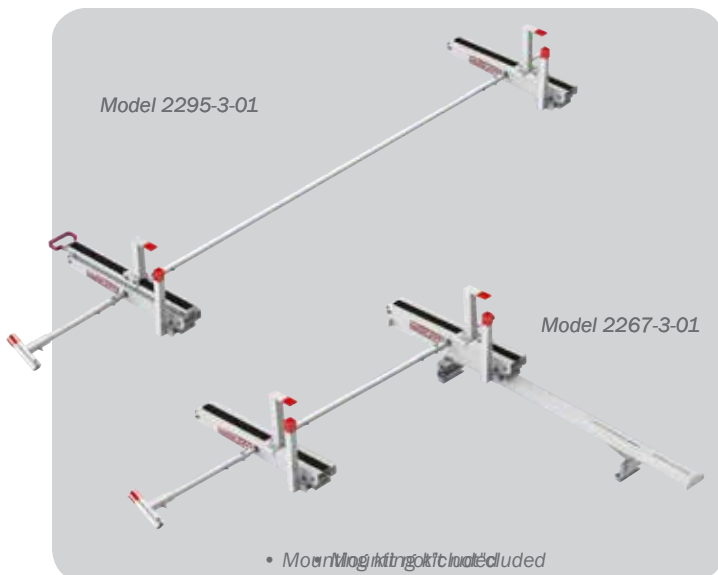

Model 2295-3-01

Model 2267-3-01

• Mounting kit not included

### Dual Drop-Down Ladder Rack Accessories

MODEL	DETAILS	WEIGHT
2295-3-01	Extended Drop-Down Long Ladder Kit - Mid-Roof/High-Roof (Cross Members not included) Installs to 2291-3-01	48 lbs.
2297-3-01	Extended Drop-Down Short Ladder Kit - Mid-Roof/High-Roof (Includes one 70" Cross Member which can be set at 42" center to center) Installs to 2291-3-01	55 lbs.
2275-3-01	Fixed Drop-Down Long Ladder Kit - Full Size (Cross Members not included)	51 lbs.
2277-3-01	Fixed Drop-Down Short Ladder Kit - Full Size (Includes one 70" Cross Member which can be set at 42" center to center) Installs to 2271-3-01	57 lbs.
2265-3-01	Fixed Drop-Down Long Ladder Kit - Compact (Cross Members not included)	58 lbs.
2267-3-01	Fixed Drop-Down Short Ladder Kit - Compact (Includes one 60" Cross Member which can be set at 42" center to center) Installs to 2261-3-01	61 lbs.
<b>NEW!</b> 2254D-3-01	Quick Clamp Add-on Kit - Driver Side	6 lbs.
<b>NEW!</b> 2254P-3-01	Quick Clamp Add-on Kit - Passenger Side	6 lbs.
2060-3-01	Accessory Cross Member - Compact (60" wide)	6 lbs.
2070-3-01	Accessory Cross Member - Full Size (70" wide)	6 lbs.

# VAN LADDER RACKS

WEATHER GUARD® Roof Racks are designed to mount through holes built into the new RAM ProMaster® & ProMaster City™. Roof rack mounting kit includes stands and hardware to improve rooftop mounting.

## STEP 1 CHOOSE A MOUNTING KIT

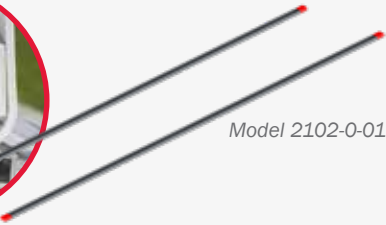

Model 2102-0-01

### Mounting Channel Kits

All Mounting Channel Kits attach to factory mounting points. No drilling required. All hardware included.

MODEL	DETAILS	WEIGHT
2115-0-01	Mounting Channel Kit - ProMaster®	15 lbs.
2085-0-01	Mounting Channel Kit - ProMaster City™	15 lbs.

## STEP 2 SELECT VAN RACK AND ACCESSORY CROSS MEMBERS

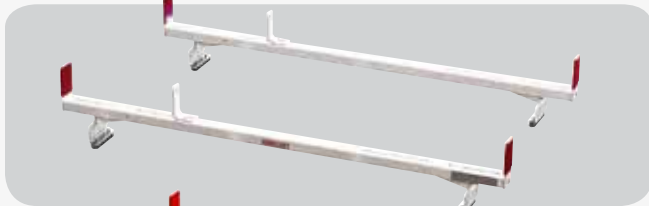

Model 224-3-03

**ADJUSTABLE SWAY BRACES**  
for easy ladder change out



### Powder Coated Aluminum Rack for ProMaster

MODEL	DETAILS	WEIGHT
209-3-03	70" All Purpose Rack	35 lbs.
2097-3-03	70" All Purpose Accessory Cross Member	19 lbs.

### Aluminum All Purpose Racks for ProMaster® City

MODEL	DETAILS	WEIGHT
218-3-03	60" All Purpose Rack	31 lbs.
222-3-03	60" All Purpose Accessory Cross Member	17 lbs.

### ! Quick Clamp Racks for ProMaster City

MODEL	DETAILS	WEIGHT
223-3-03	60" Single Quick Clamp Rack (curb-side only)	44 lbs.
224-3-03	60" Dual Quick Clamp Rack	54 lbs.
225-3-03	60" Quick Clamp Accessory Cross Member	16 lbs.

### Sliding Ladder Racks

Our Sliding Ladder Rack provides quick and easy ladder storage inside your van. Rugged and durable, this rack fits up to 8-foot step, extension ladders when mounted to the roof.

MODEL	DETAILS	WEIGHT
250	Sliding Ladder Rack	27 lbs.

# CONDUIT CARRIERS



Model 239

Model 237

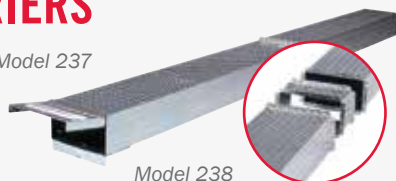

Model 238

### Aluminum Conduit Carrier

Keep your conduit safe, secure, and clean with our lightweight and durable Conduit Carrier.

MODEL	DETAILS	LENGTH	WIDTH	HEIGHT	WEIGHT
237	Conduit Carrier	121½"	11"	6"	40 lbs.
238	Extension	6"	11"	6"	4 lbs.
239	PVC Conduit Carrier Kit				4 lbs.

PVC not included. Separately purchase a section of standard 6" PVC (9ASTM D2665) plastic drain pipe. Coordinate the length of the PVC with the length of conduit you'll be carrying.



## RAM PROMASTER®

The dimensions show in this guide refer to model year 2018 and earlier RAM Promaster vans. Always measure your van carefully to make sure that the equipment you choose will fit properly. Verify the location of the gas tank, brake lines, wiring harness, etc. before installing any equipment. Shelving Mounting Kits are recommended. Do not exceed the van manufacturer's roof load rating.

- Low Roof
- High Roof
- 118" Wheel Base
- 138" Wheel Base
- 159" Wheel Base
- 159" Extended Wheel Base

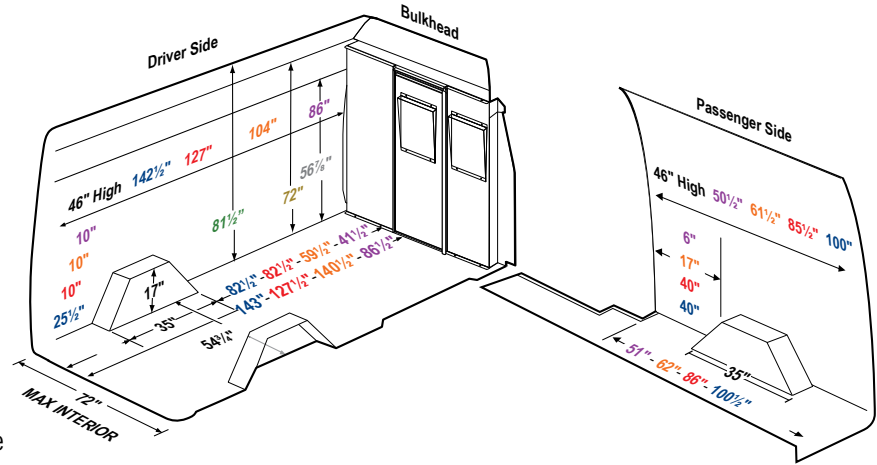

## RAM PROMASTER CITY™

The dimensions show in this guide refer to model year 2018 and earlier RAM ProMaster City vans. Always measure your van carefully to make sure that the equipment you choose will fit properly. Verify the location of the gas tank, brake lines, wiring harness, etc. before installing any equipment. Shelving Mounting Kits are recommended. Do not exceed the van manufacturer's roof load rating.

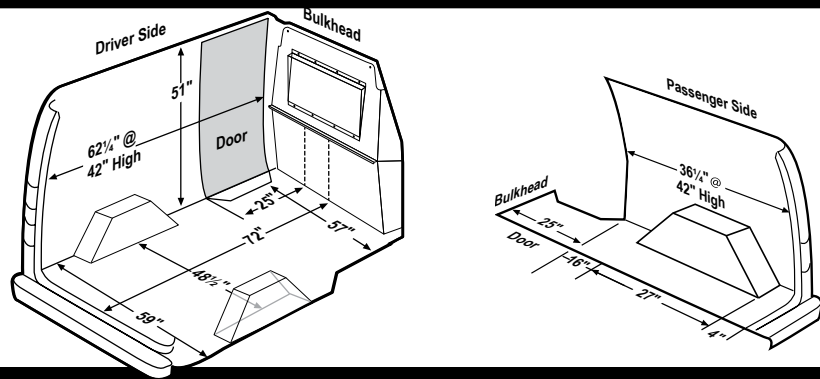

Always measure your van carefully to make sure that the equipment you choose will fit properly. Verify the location of the gas tank before installing any equipment. Shelving Mounting Kits are recommended. Do not exceed the van manufacturer's roof load rating.



### LIMITED LIFETIME WARRANTY

Knaack LLC (the Manufacturer) warrants to the original purchaser, only, that WEATHER GUARD® van products (the "WEATHER GUARD Product") will be free from defects in material and workmanship from the date of purchase and continuing for the expected lifetime of the WEATHER GUARD Product. Please call our customer service department toll free at 1.800.456.7865 with any questions or comments.

DO NOT use these products for storing or transporting flammables, explosives, hazardous materials or waste, such as gasoline, solvents, gun powder, dynamite, gases or any tanks, torches or gas powered equipment. These products are intended and safe for storing and transporting small tools and other non-combustible, non-flammable materials. Any modification made to, or unintended use of, these products may create a dangerous condition causing death, serious bodily injury or property damage.

#### NOTICE

Any modification or unintended use of these products shall immediately void all manufacturers warranties. Manufacturer disclaims all liability for injuries to persons or property resulting from any modification to, or unintended use of these products.

Ford Transit Connect, Nissan NV, Mercedes Sprinter, and Dodge Ram CV are registered trademarks of their respective owners.

For information on the WEATHER GUARD® Van Solutions Limited Lifetime Warranty, visit [www.weatherguard.com](http://www.weatherguard.com)  
To order more WEATHER GUARD® Van Solutions OEM brochures, please call us at **800.456.7865**



©2018 Knaack, LLC. All rights reserved.

CONTACT YOUR LOCAL DISTRIBUTOR/UPFITTER